



Catálogo 2012



Buick

CENTURY
(94-95)

Número de parte
C-3036

DESCRIPCIÓN		PART #	OE #
ARBOL DE LEVAS	40T	S756T	10166350
CIGUEÑAL	20T	S619	14074400
CADENA	64L	C385	10166352



Buick

CENTURY, REGAL
2.8L/3.1L (87-93)

Número de parte
C-3048K

DESCRIPCIÓN		PART #	OE #
ARBOL DE LEVAS	40T	S620T	14074399
CIGUEÑAL	20T	S619	14074400
CADENA	64L	C359	14102671



Buick/Chevrolet

**Century,
Impala, Malibu
V6 3.1L, V6 3.4L, V6 3.5L
(1999-2005)**

**Número de parte
9-0700S**

DESCRIPCIÓN		PART #	OE #
ARBOL DE LEVAS	50T	S848T	24506089
CIGUEÑAL	25T	S847	12568125
CADENA	80L	C700	24506090
AMORTIGUADOR		9-5388	24507720



**Buick/Chevrolet/
Oldsmobile/Pontiac**

**SKYLARK;
CAVALIER, MALIBU;
ACHIEVA, ALERO;
GRAND AM, SUNFIRE;
L4 2.4L (96-02)**

**Número de parte
S-804T**

DESCRIPCIÓN		PART #	OE #
ARBOL DE LEVAS	38T	S-804	24575543





Chevrolet

350-305
(75-88)

Número de parte
C-3023K

DESCRIPCIÓN		PART #	OE #
ARBOL DE LEVAS	44T	S288	3735412
CIGUEÑAL	20T	S289	3735413
CADENA	58L	C163	3735411



Chevrolet

5.7L
(85-96)

Número de parte
C-3059K

DESCRIPCIÓN		PART #	OE #
ARBOL DE LEVAS	36T	S390T	340235
CIGUEÑAL	18T	S505	464617
CADENA	46L	C499	14087014



Chevrolet

BLAZER
V6 4.3L
(00-02)

Número de parte
C-3212

DESCRIPCIÓN		PART #	OE #
ARBOL DE LEVAS	56T	S836T	12555670
CIGUEÑAL	28T	S835	12555671
CADENA	72L	9-4190	12555672

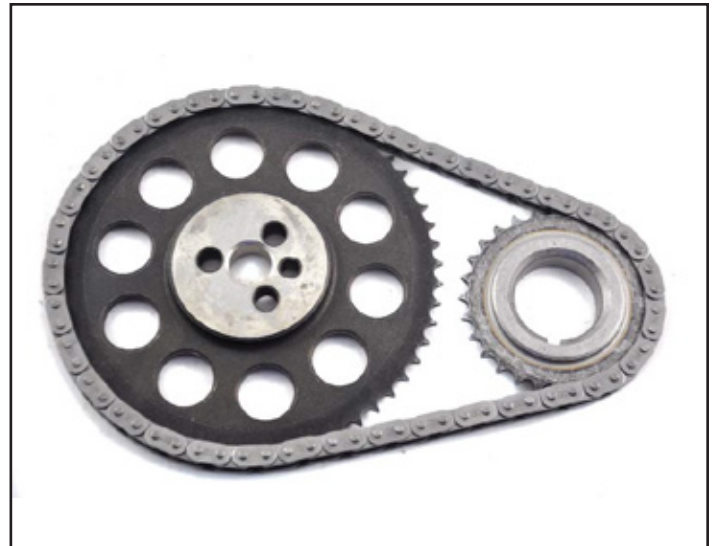

Chevrolet

BLAZER
V6 4.3L
(95-99)

Número de parte
C-3096

DESCRIPTION		PART #	OE #
ARBOL DE LEVAS	36T	S776T	10144121
CIGUEÑAL	18T	S505	464617
CADENA	46L	C499	14087014





Chevrolet

**BLAZER 4.3L
(91-94)**

Número de parte
C-3056K

DESCRIPCIÓN		PART #	OE #
ARBOL DE LEVAS	36T	S732T	10168441
CIGUEÑAL	18T	S505	464617
CADENA	46L	C499	14087014



Chevrolet

**CAVALIER, MALIBU;
OLDSMOBILE ACHIEVA,
ALERO; PONTIAC GRAND AM,
SUNFIRE L4 2.4L (96-02)**

Número de parte
C-3204

DESCRIPCIÓN		PART #	OE #
ARBOL DE LEVAS	38T	S804T	24575543
CIGUEÑAL	19T	S805	24575544
CADENA	130L	C390	24574447

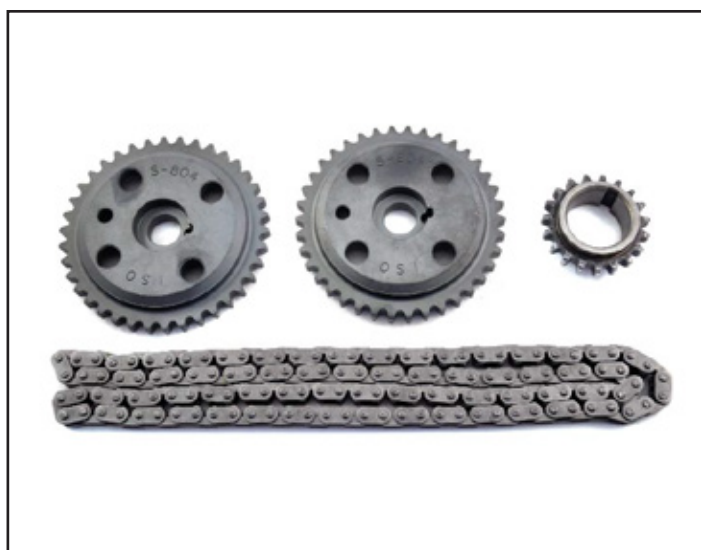

Chevrolet

750/305
C/K PICKUP
(77-88)

Número de parte
C-3001K

DESCRIPCIÓN		PART #	OE #
ARBOL DE LEVAS	36T	S390T	340235
CIGUEÑAL	18T	S391	3896959
CADENA	46L	C499	14087014



**Chevrolet/GMC/
Oldsmobile/Pontiac**

CAVALIER, CORSICA, LLV,
LUMINA, S10; SONOMA;
FIRENZA; J2000, SUNBIRD,
SUNFIRE, TEMPEST
L4 2.0L, L4 2.2L (1983-2002)

Número de parte
C-370

DESCRIPCIÓN		PART #	OE #
Cadena	58L	C370	24577247

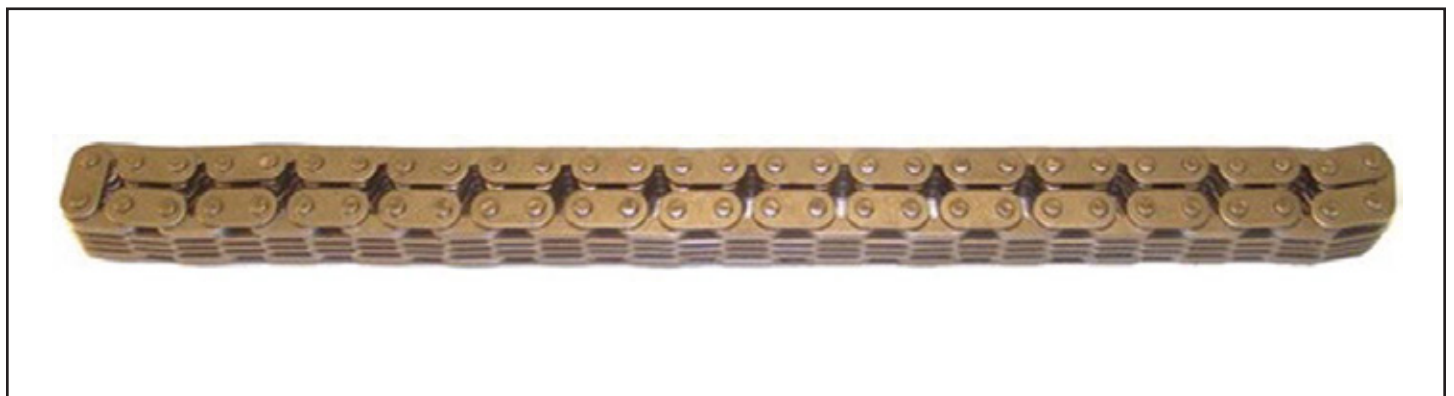



Chevrolet

Chevy, Monza, Tornado
1994-2005

Número de parte
BK203

1.4L - 1.6L 4 Cil.

Descripción	Número de parte	OE#
Banda de distribución	B203	90531677
Tensor de banda	9-9401	90499401
Kit de banda	BK203	

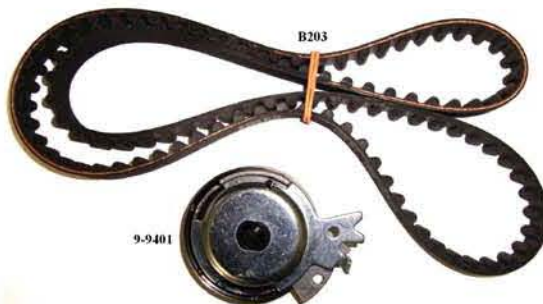

Chevrolet

Aveo, 2004-09
Pontiac G3 2004-09

Número de parte
BK335

1.6L -6,D(98) 4 Cil. (L91, LXT Engines)

Descripción	Número de parte	OE#
Banda de distribución	127T B335	96858745
Tensor de banda	9-5494	96350550
Tensor Auxiliar ó Rueda Loca	9-5495	96350526
Kit de banda	BK335	

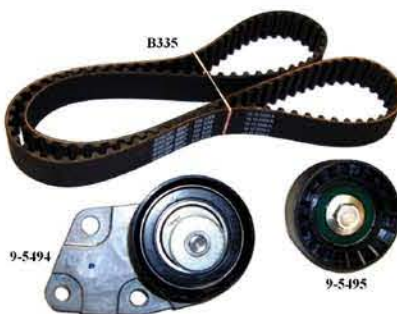

Chevrolet

Astra. Zafira
2000-03

Número de parte
BK406

1.8L 4 Cil.

Descripción		Número de parte	OE#
Banda de distribución	162T	B406	24451895
Tensor de banda		9-9418	24426500
Tensor Auxiliar ò Rueda Loca		9-9422	55350580
Tensor Auxiliar ò Rueda Loca		9-9423	55352713
Kit de banda		BK406A	



Chevrolet

Chev. Tracker 1998-04,
Geo Tracker 1994-01
Suzuki Sidekick, X-90, Swift, Esteem,
Vitara 1992-01.

Número de parte
BK212

1.6L -6 (98) 16V 4 Cyl. (L01 Engine)

Descripción		Número de parte	OE#
Banda	103T	B212	96068591
Tensor de banda		9-5282	96068592
Kit de banda		BK212	





Chevrolet

Chev. Cobalt 2.0L 2005-07.
Cavalier, HHR, Malibu 2002-08,
Astra, Zafira 2001-03, Olds. Alero 2002-04
Pontiac Sunfire, Grand Am 2002-08
Saturn L-Series, Ion, Vue 2000-07

Número de parte
9-4201S
9-4202S

2.0L -P (122) 2.2L -D, F, 6 (134) DOHC 4Cil. (L61 engine)

Descripción	Número de parte	OE#
† Árbol de levas	46T S850T	90537632
† Cigüeñal, (Externo)	23T S849	24424758
• Cigüeñal, (Interno)	42T S851	90537301
† Cadena	148L 9-4201	24461834
† Tornillo Árbol de levas	9-5496	90537451
† Tensor	9-5374	12578209
† Guía, (DER.)	134L 9-5375	24449448
† Guía, (IZQ.)	9-5381	13104978
† Guía, (Superior)	9-5382	90537337
• Bal. Shf. Cadena	9-4202	90537370
• Bal. Shf. Guía, (DER.)	9-5384	90537299
• Bal. Shf. Guía, (IZQ.)	9-5385	90537369
• Bal. Shf. Guía, (Superior)	9-5386	90537336
• Bal. Shf. Sprocket, (Intake)	21T S853	90537435
• Bal. Shf. Sprocket, (Exhaust)	21T S855	90537295
• Bal. Shf. Tensor	9-5383	90537300
Sprocket bomba de agua	S911	90537298
† Roceador de Aceite	9-5467	12577163
† Timing Kit (Cam Shaft)	9-4201S	24461834
• Timing Kit (Bal. Shaft)	9-4202S	21018823

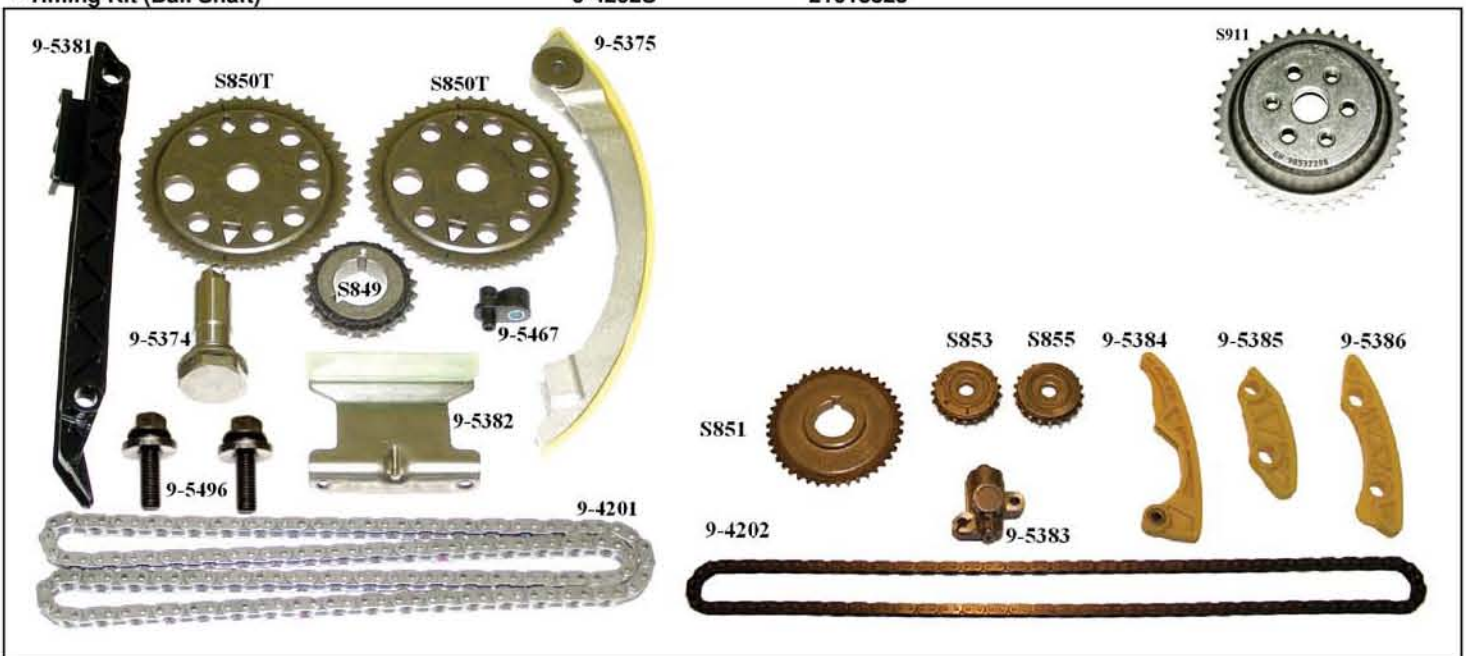
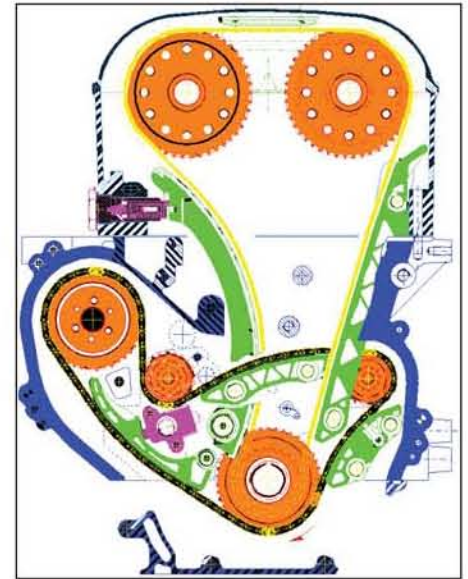

Chevrolet

Bereta 1994-96, Cavalier 1994-02
 Corsica 1994-96, S-10 1994-03.
 Buick Century 1994-96. GMC Sonoma
 1994-02, Isuzu Hombre 1996-00,
 Olds Cutlass Ciera 1994-96,
 Pontiac Sunfire 1995-02.

Número de parte
C-3019
9-0370S

2.2L -G, 4, 5 (134) 4 Cil. LN2, L43, LM3 Engine

Descripción	Número de parte	OE#
† • Árbol de levas 40T	S774T	8101988100
† • Cigüeñal 20T	S549	8100831710
† • Cadena 58L	C370	8140627020
• Tensor	9-5115	8140817120
† 3 Pc. Set	C-3019	
• Timing kit	9-0370S †	

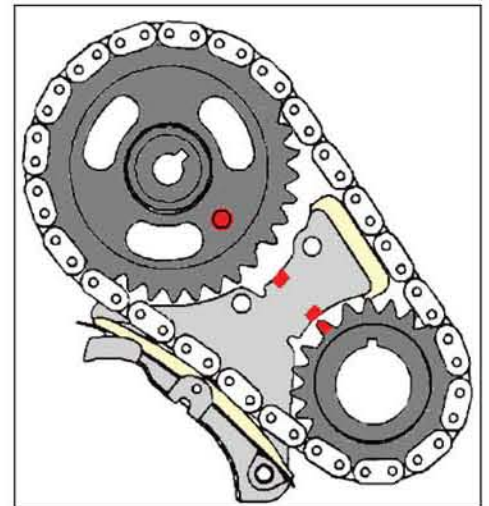

1.- Nuevo kit incluye todos los componentes





Chevrolet

Buick Skylark 1996-98.
Chevrolet Cavalier, Malibu 1996-02.
Olds Alero, Achieva 1996-01.
Pontiac Grand Am, Sunfire 1996-02

Número de parte
9-0390S

2.4L -T (146) DOHC 4 Cyl. (LD9 Engine)

Descripción	Número de parte	OE#	
†• Árbol de levas	38T	S804T 1	24575544
†• Cigüeñal	19T	S805	24574447
†• Cadena	130L	C390	24573179
Tensor , (1996)		9-5294	24575512
• Tensor , (1997-02)		9-5356	24575513
• Zapata de Tensor, (1997-02)		9-5355	24575256
• Guía , (R.H.)		9-5365	24575257
• Guía , (L.H.)		9-5366	24575255
• Guía , (Superior)		9-5367	24574411
Guía, (Bal. Shaft)		9-5368	
Bal. Shf. Cadena	72L	9-4195	24574130
Bal. Shf. Spkt. , (conductor)	24T	S828	24573813
Bal. Shf. Spkt. , (conducido)	48T	S829	
† 3 Pc. Set		C-3204	
• Timing Kit , (1998-97)		9-0390S 2	
Timing Kit , (Sin Sprockets)		9-0390SX	
Timing Kit, (Bal. Shaft)		9-4195S	

1 - 2 Requeridos

2 -Para Camshaft

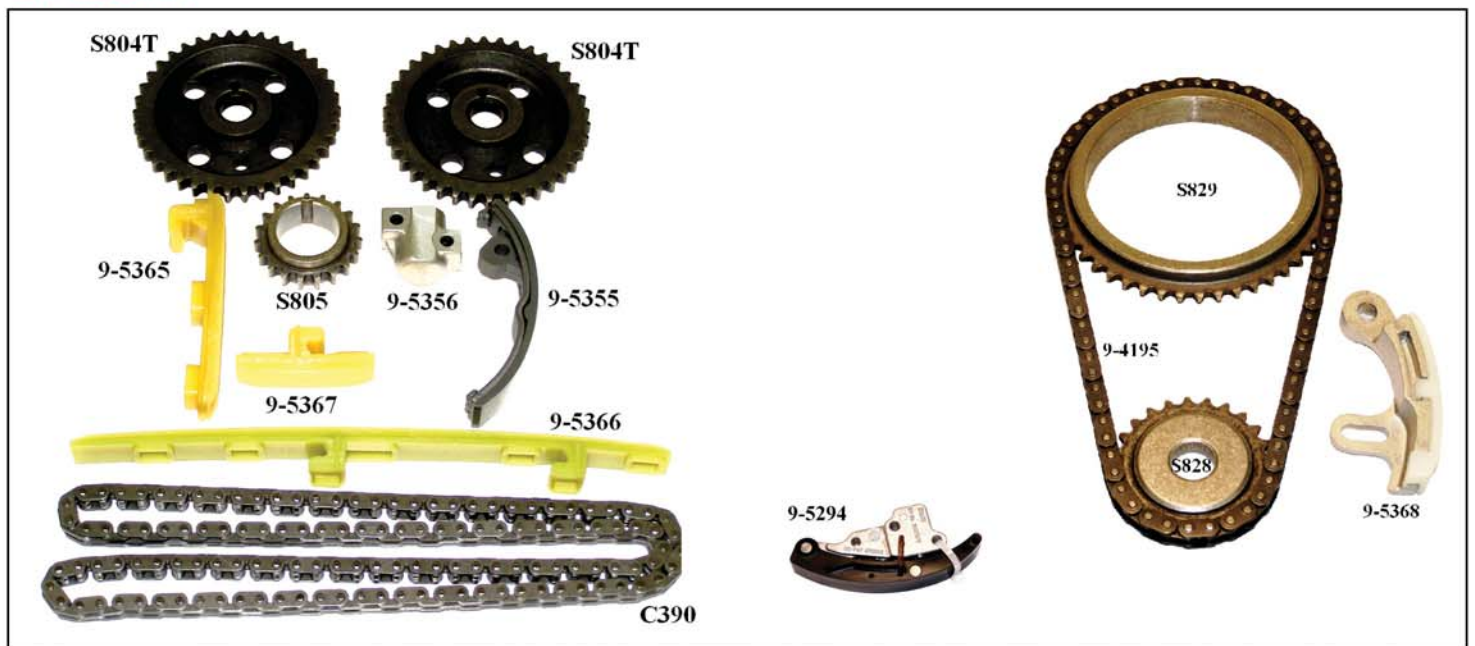

Chevrolet

OPTRA DESIGN

Número de parte
BK-707

DESCRIPCIÓN	OEM #
BANDA DE DISTRIBUCION	24451895
TENSOR DE BANDA GRANDE	96413862
TENSOR AUXILIAR, RUEDA LOCA	96413863
TENSOR AUXILIAR, RUEDA LOCA	96413864





Chevrolet

OPTRA LIMITED

Número de parte
BK-710

DESCRIPCIÓN	OEM #
BANDA DE DISTRIBUCION	92066312
TENSOR DE BANDA	90530126
TENSOR AUXILIAR, RUEDA LOCA	96413863



Chevrolet

Trail Blazer, Colorado, Envoy 2002-07.
 Buick Rainier 2004-07. Olds Bravada.
 Isuzu Ascender 2003-07.
 Saab 9-7X 2005-07

Número de parte
9-0195S

4.2L -S (256) 6 Cil en línea

Descripción	Número de parte	OE#
Árbol de levas	58T S908	24100362
Cigüeñal	29T S913	24100061
Cadena	168L C195	17571725
Tensor	9-5512	12598504
Guía	9-5506	12575159
Brazo tensor	9-5504	12568766
Timing Kit	9-0195S	

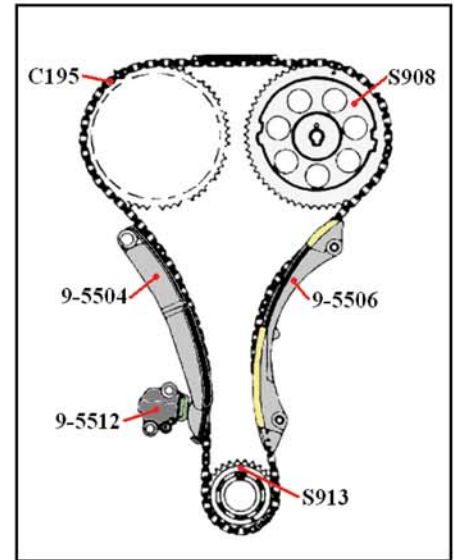



Chevrolet

GMC Colorado
Canyon, Hummer H3 2007-09.
Isuzu I-290 2.9L 2007-08
I-370 3.7L 2007-08

Número de parte
9-0195SA

2.9L -9 (178) 4 Cil en línea
3.7L -E (223) 5 Cil en línea

Descripción		Número de parte	OE#
Árbol de levas	58T	S908	24100362
Cigüeñal	29T	S913	24100061
Cadena	168L	C195	12571725
Tensor		9-5512	12598504
Guía, (IZQ.)		9-5510	12590962
Bal. Shf. Cadena	110L	C728F	12595030
Bal. Shf. Tensor		9-5511	12588100
Brazo tensor, (DER.)		9-5504	12568766
Timing Kit		9-0195SA	



<h1>Chevrolet</h1>	Trail Blazer, Colorado, Envoy 2008-09. Buick Rainier, Olds Bravada 2002-04. Isuzu Ascender 2008. Saab 9-7X 2008	Número de parte 9-0195SB
	4.2L -S (256) 6 Cil en línea	

Descripción	Número de parte	OE#
Árbol de levas	58T S908	24100362
Cigüeñal	29T S913	24100061
Cadena	168L C195	12571725
Tensor	9-5512	12598504
Guía ,	9-5510	12590962
Brazo tensor	9-5504	12568766
Timing Kit,	9-0195SB	

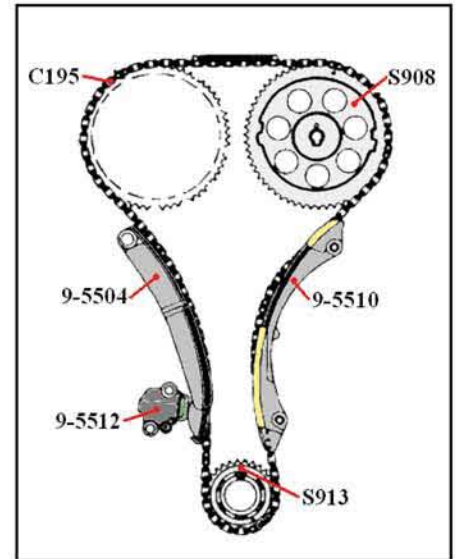



Chevrolet	Colorado Canyon, Hummer H3 2006. Isuzu I-280 2006, I-350 2006	Número de parte 9-0195SC
	2.8L -8 (169) 4 Cil. 3.5L -6 (211) 5 Cil.	

Descripción	Número de parte	OE#
Árbol de levas	58T S908	24100362
Cigüeñal	29T S913	24100061
Cadena	168L C195	12571725
Tensor	9-5512	12598504
Guía, (IZQ.)	9-5506	12575159
Cadena eje de balanceo	110L C728F	12595030
Tensor eje de balanceo	9-5511	12588100
Brazo tensor, (DER.)	9-5504	12568766
Timing Kit	9-0195SC	



Chevrolet

Silverado 1500, GMC 2007-09

Número de parte
C-3233

4.3L -X (262) V6

Descripción		Número de parte	OE#
Engrane de Árbol	56 T	S928T	93800963
Engrane de cigüeñal	28T	S835	12555671
Cadena	72L	9-4190	12555672
3 Pc. Set		C-3233	89060443





Chevrolet/GMC

TRUCKS
V6 4.3L (93-00)

Número de parte
C-3090

DESCRIPCIÓN		PART #	OE #
ARBOL DE LEVAS	40T	S756T	10166350
CIGUEÑAL	20T	S619	14074400
CADENA	64L	C385	10166352



Chevrolet

750/305
C/K PICKUP (77-88)

Número de parte
3001K

DESCRIPCIÓN		PART #	OE #
ARBOL DE LEVAS	36T	S390T	340235
CIGUEÑAL	18T	S391	3896959
CADENA	46L	C499	14087014



Chevrolet/GMC

TRUCKS
V8 4.8L, V8 5.3L, V8 6.0L
(2000-2004)

Número de parte
C-3210

DESCRIPCIÓN		PART #	OE #
ARBOL DE LEVAS	44T	S826T	12576407
CIGUEÑAL	22T	S827	12556582
CADENA	60L	9-4194	12552954



Chevrolet/GMC

TRUCKS
V8 5.0L, V8 5.7L
(1996-2002)

Número de parte
C-3017

DESCRIPCIÓN		PART #	OE #
ARBOL DE LEVAS	36T	S732T	10168441
CIGUEÑAL	18T	S797	10128346
CADENA	46L	C499	14087014





Chrysler

Atos 2001-2004

Número de parte
BK401

1.0L OHC 4 Cil.

Descripción	Número de parte	OE#	
Banda de distribución	101T	B401	2431202701
Tensor de banda		9-9404	24410-02550
Kit de banda		BK401	89060443



Chrysler

Chrysler New Yorker, Laser, Lebaron
1980-88. Dodge Aries, Charger,
 Daytona, Lancer, Omni, Shadow **1980-**
88. Caravan, Dakota, Ram Van 1983-
89. Plymouth Caravelle, Expo,
 Horizon, Reliant, Voyager **1980-88**

Número de parte
BK071

2.2L -B, C, E (135) 4 Cyl.

Descripción	Número de parte	OE#	
Árbol de levas	40T	S616	4201974
Cigüeñal , (1987-81)	20T	S417	5203575
Banda	124T	B071	5203401
Tensor de banda		9-5091	5203469
Kit de banda		BK071	

1 - 2 Requeridos



Chrysler

Neon, Stratus, Breeze 1995-99

Número de parte
BK245

2.0L -C (122) SOHC 4 Cil. (ECB, ECH Engines)

Descripción	Número de parte	OE#
Banda	112T B245 ¹	4667606
Tensor de banda	9-5499 ²	4667283
Polea oca , (1999-1995)	9-5405	4777394
Kit de Banda, (1999-1995)	BK245	

1 - Motor con interferencia

2 - Hidráulico



Se vende por separado



Chrysler

Sebring, Avenger, Neon 1995-99.
Eagle Talon 1995-98.
Mitsubishi Eclipse 1995

Número de parte
BK246

2.0L -Y (122) DOHC 4 Cyl. (A588 Engine)

Descripción	Número de parte	OE#
Banda	150T B246 ¹	4667611
Tensor de banda	9-5499 ²	4667283
Polea oca , (Inferior)	9-5405	4777394
Polea oca , (Superior)	9-5405	4777394
Kit de banda	BK246	

1 - Motor con interferencia

2 - Hidráulico



Se vende por separado





Chrysler/Dodge

Cirrus, Sebring; Avenger, Stratus
V6 2.5L, V6 3.0L
(1995-2005)

Número de parte
BK-259

DESCRIPCIÓN		PART #	OE #
Correa	187T	B259	MD307487
Tensor Auxiliar, Rueda Loca (Superior)		9-5227	MD319022
Tensor Auxiliar, Rueda Loca (Inferior)		9-5271	MD140071



Chrysler/Dodge

Concorde, Sebring;
Intrepid, Stratus
V6 2.7 (2002-2004)

Número de parte
9-0397S

DESCRIPCIÓN		PART #	OE #
Arbol de Levas (Derecho)	42T	S840	4792306
Arbol de Levas (Izquierdo)	42T	S860	4792305
Cigüeñal	21T	S839	4663632
Cadena (Secundaria)	44L	C193A	4663674AC
Cadena (Primaria)	180L	C397	4663635
Tensor (Secundario)		9-5404	4663676
Tensor (Primario)		9-5422	4792443AB
Brazo Tensor		9-5403	4663634AB
Guía (Izquierda)		9-5400	4663636
Guía (Izquierda)		9-5401	4663637
Guía (Derecha)		9-5402	4792104



Chrysler/Dodge

Concorde; Intrepid
V6 2.7L 2700cc
(1998-1999)

Número de parte
9-0397SB

DESCRIPCIÓN		PART #	OE #
Arbol de Levas (Derecho)	42T	S840	4792306
Arbol de Levas (Izquierdo)	42T	S860	4792305
Cigüeñal	21T	S839	4663632
Cadena (Secundaria)	44L	C193A	4663674AC
Cadena (Primaria)	180L	C397	4663635
Tensor (Secundario)		9-5404	4663676
Tensor (Primario)		9-5453	4792443AA
Brazo Tensor		9-5403	4663634AB
Guía (Izquierda)		9-5400	4663636
Guía (Izquierda)		9-5401	4663637
Guía (Derecha)		9-5402	4792104



Chrysler/Dodge

LeBaron, New Yorker;
Daytona, Dynasty, Caravan,
Grand Caravan, Mini Ram
V6 3.0 2972cc (1987-2000)

Número de parte
BK-139

DESCRIPCIÓN		PART #	OE #
Correa	149T	B295	4792353
Tensor		9-5357	4663515





Chrysler

**Dodge/Chrysler Stratus, Cirrus, PT
Cruisier, Voyager, Caravan,
Plymouth Breeze,
Jeep Liberty
1995-2006**

**9-4191SA
BK265A
BK265B**

2.4L - (148) DOHC 4 Cil. (16V EDZ Engine)

Descripción	Número de parte	OE#
▶ † Banda de distribución	146T	B265 4621844
† Tensor	9-9413A	5010371AA
▶ Tensor	9-9413B	04781570AB
• Cigüeñal , (Cadena)	36T	S803 4621541
• Bal. Shf. Cadena , (w/o Turbo)	60L	9-4191 4621996
• Bal. Shf. Guía , (w/o Turbo)	9 -5297	4343660
• Bal. Shf. Spkt.	18T	S642 4483485
• Bal. Shf. Tensor , (w/o Turbo)	9-5298	4343662
• Timing Kit , (w/o Turbo)	9-4191SA	
† Kit de banda	BK265A	(1st Design)
▶ Kit de banda	BK265B	(2nd Design)

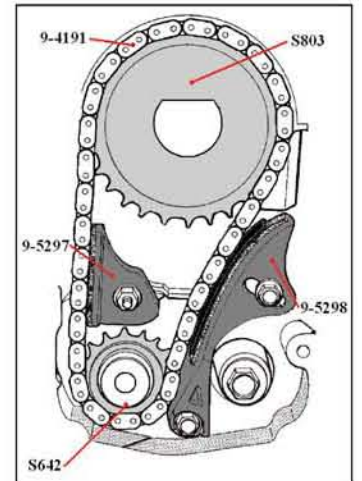

Chrysler

**American Motors 1923-84.
Eagle Premier 1988-89.
Dodge Caravan, Dakota, Ram Van,
Voyager Van 1996-02.
Jeep Cherokee, CJ7, Comanche,
Wagoneer, Wrangler 1983-02.**

**Número de parte
9-4023S
C-3062**

2.5L -E, H, P, U (150) 4 Cyl.

Descripción	Número de parte	OE#
†• Árbol de levas	48T	S608T
†• Cigüeñal	24T	S607
†• Cadena	64L	9-4023
• Tensor	9-5167	33003421
• Damper	9-5337	33003446
† 3 Pc. Set	C-3062	
• Timing Kit	9-4023S	

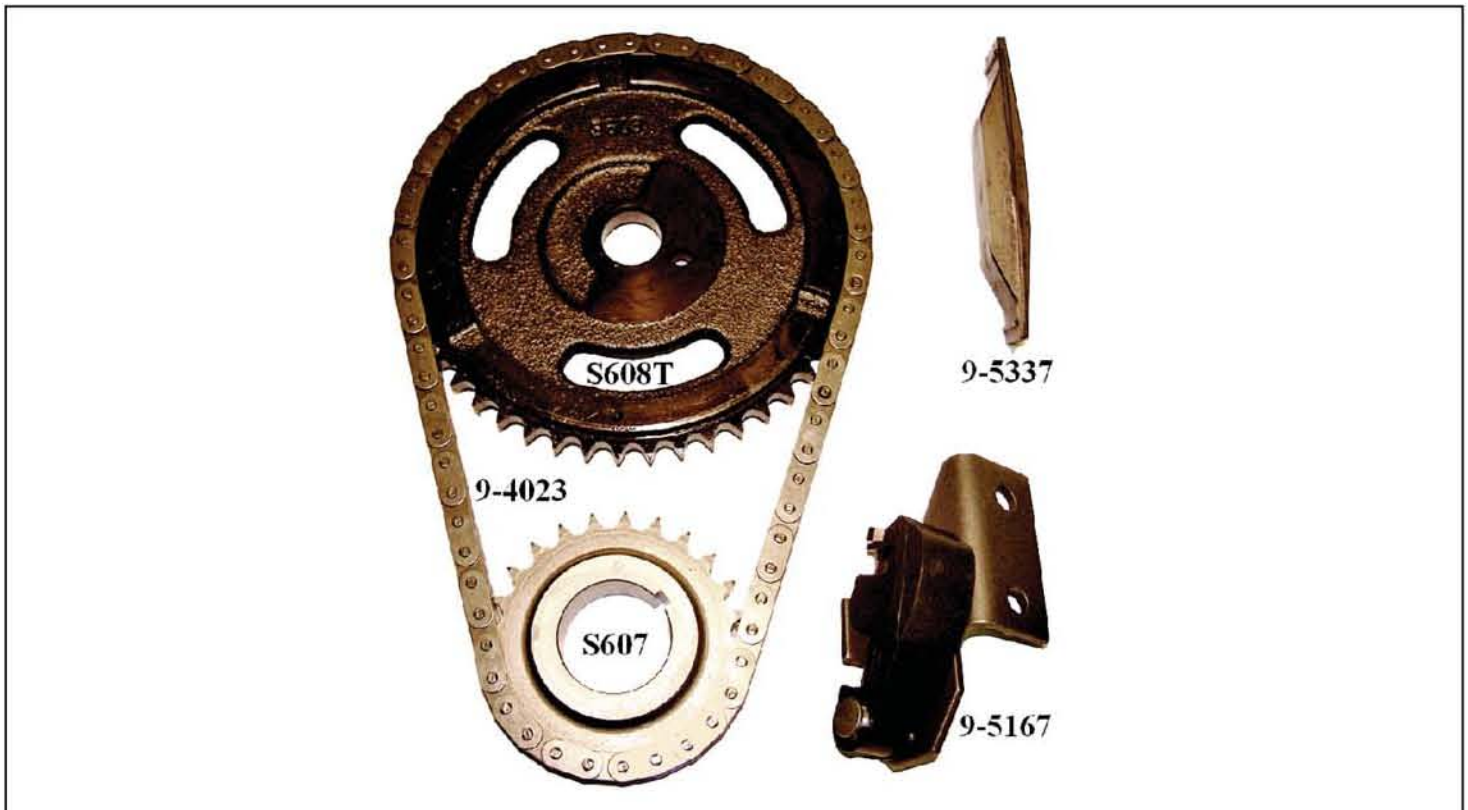
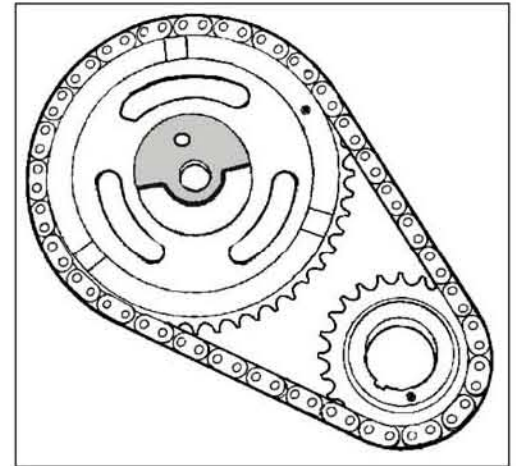



Chrysler

Chrysler 2.6L Lebaron, New Yorker, Town & Country 1984-89.
Dodge Aries, Challenger, Conquest 1981-89
 Ram Van, Raider, Ram 50 **1978-89.**
 Colt, D50 2.0L **1974-80. Mazda B2600 1987-98**
Mitsubishi Truck, Montero, Starion 1983-90.
Plymouth 1978-89

Número de parte
9-4188S
9-4131SA
9-4145S
9-4145SA

2.6L -F, W, (2600CC) , F2600, W2600, U2000, 2.0L -U (122) (G54B, G52B Engine)

Descripción	Número de parte	OE#
† Árbol de levas	38T S458	MD021246
• Cigüeñal , (Externo)	34T S407	MD021170
† Cigüeñal , (Interno)	19T S455	MD020843
† Cadena	102L 9-4131	MD154048
► Cadena	50L 9-4188 1	
† Guía , (Lado de Tensión)	90L 9-5030	MD153644
† Guía , (Lado de Flojo)	9-5031	MD021232
• Guía , (IZQ.)	9-5048 2	MD021111
• Guía, (Inferior DER.)	9-5051 2	MD021114
• Guía, (DER.)	9-5064 2	MD021156
• Bal. Shf. Cadena	9-4145	MD172895
• Bal. Shf. Spkt.	17T S567 3	MD021172
† Vástago	9-5049	MD021233
► Bal. Shf. Elimination Kit	9-4188S	
† Timing Kit , (Para árbol de Levas)	9-4131SA	
• Timing Kit , (For Bal Shaft)	9-4145S	
Timing Kit , (Completo)	9-4145SA 4	

1 - For Balance Shaft Elimination Kit

2 - Para Balance Shaft

3 - 2 Requeridos

4 - Incluye 9-4131SA y 9-4145S



Chrysler

Dodge Dakota, D100/150, W100/150, B100/150/1500 **3.9L 1991-03**. Dakota, Durango, D100, 150, 1500, 200, 250, 2500, Ramcharger **5.2L 1990-03**. Jeep Grand Cherokee, Wagoneer **5.2L 1993-98**. Grand Cherokee **5.9L 1998**

Número de parte
C-3072

3.9L -X(238) V6
5.2L -T, Y(318) STD V8
5.9L -5, Z(360) STD V8 1990-03 silent type Cadena

Descripción	Número de parte	OE#	
† Árbol de levas	46T	S712T	4448675
† Cigüeñal	23T	S721	4448674
† Cadena	68L	C380	53005773
Tensor	9-5387 1		53021195AA
† 3 Pc. Set	C-3072		

1 - Solo para 3.9L -X V6. Se vende por separado





Chrysler

Concorde, Dynasty, Intrepid, New Yorker, Voyager, Caravan 3.3L 1990-03. Imperial, Pacifica, Town & Country, Voyager 3.8L 1991-03. Dynasty, Intrepid 3.3L 1990-97. Caravan 3.8L 1994-03. Eagle Vision 3.3L 1993-96

Número de parte
C-3077

3.3L -R, T, U, J (201) V6
3.8L -L (230) V6

Descripción		Número de parte	OE#
† Árbol de levas	40T	S788T	4778707
† Cigüeñal	20T	S715	4448154
† Cadena	64L	C388	4740275
†3 Pc. Set		C-3077	

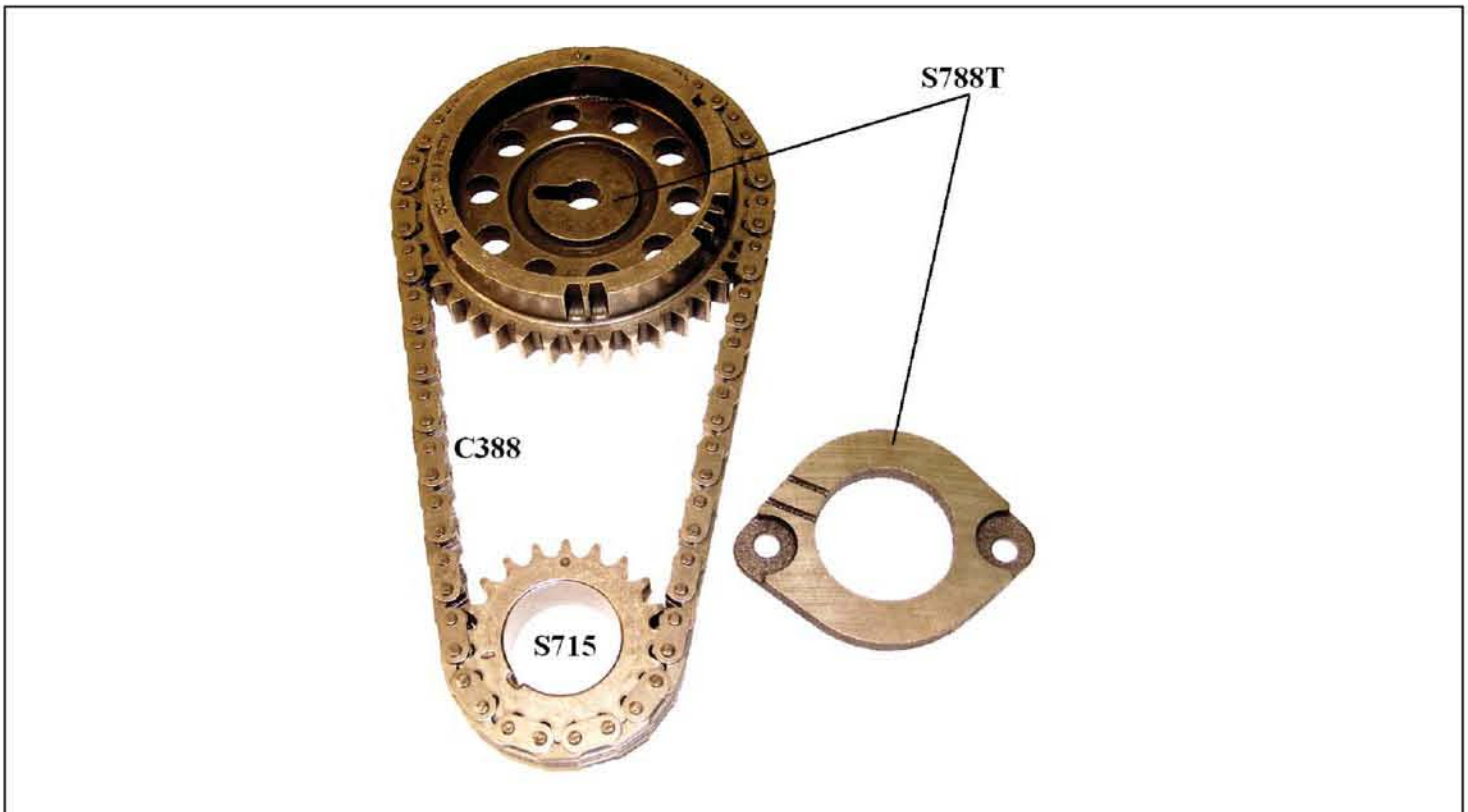
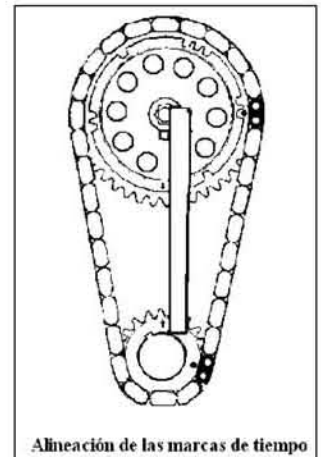

Chrysler

Charger, Magnum, Ram 1500-3500,
Durango 2002-2006

Número de parte
9-0704S

5.7L(345) , 6.1L(370) Hemi V8

Descripción	Número de parte		OE#
†• Árbol de levas	52T	S896T	53021304AE
†• Cigüeñal	26T	S889	53021307AA
†• Cadena	86L	C704	53021308AC
• Tensor		9-5489	53021582AD
† 3 Pc. Set		C-3232	53021308AC
• Timing Kit		9-0704S	

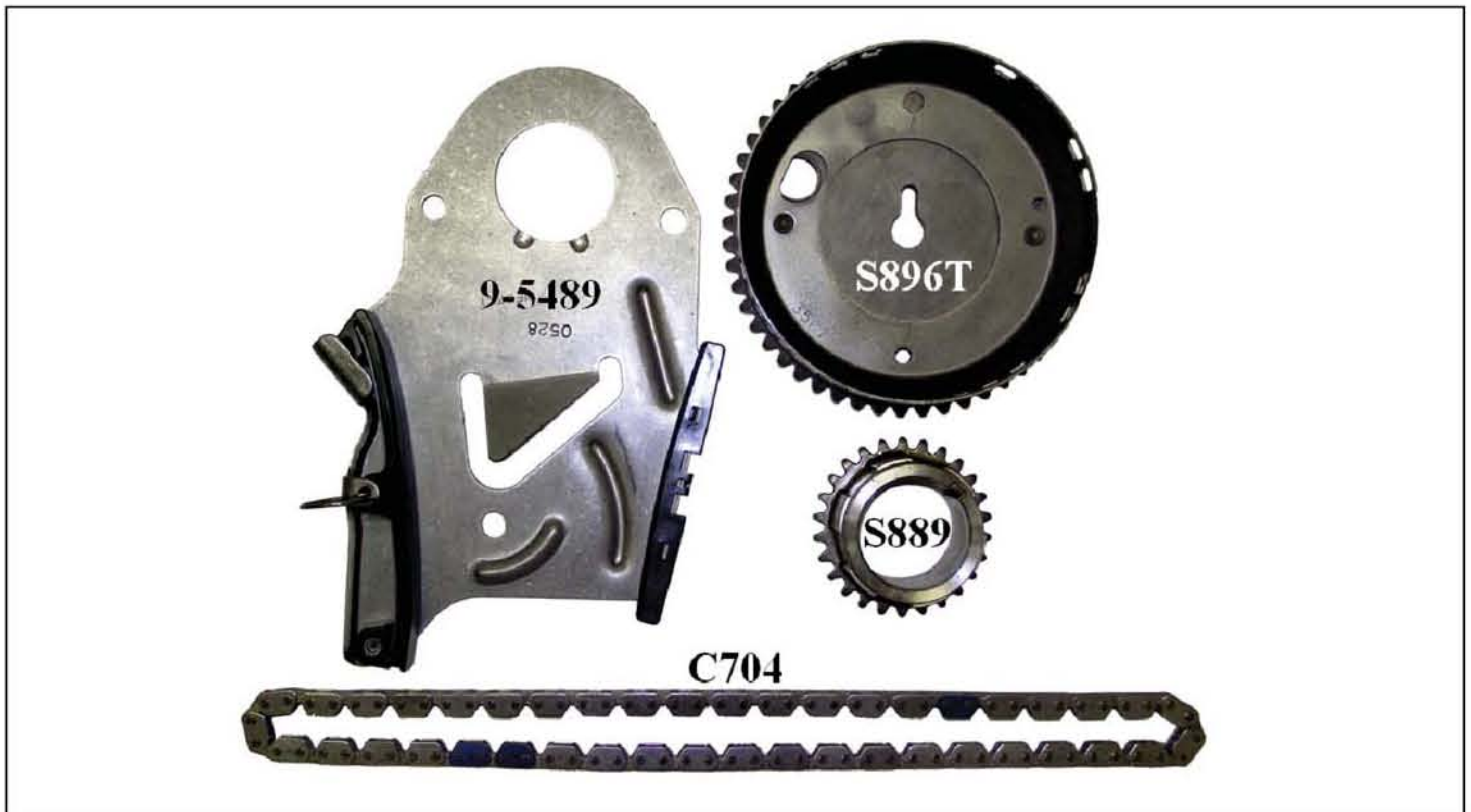
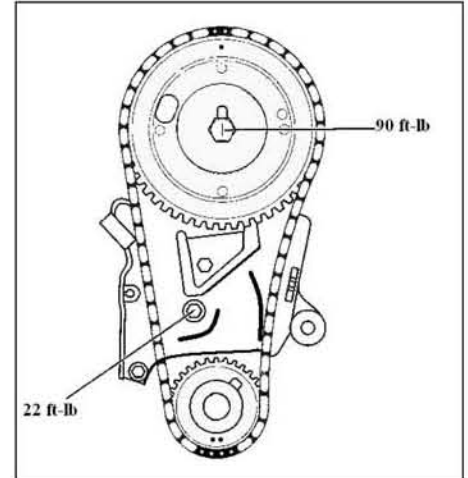



Chrysler

Dakota 1999-01. Durango, Ram,
PickUP 1999-02.
Jeep Grand Cherokee 1999-04
Con JTEC Target Wheel

Número de parte
9-0393S

4.7-N, J (287) SOHC V8

Descripción	Número de parte		OE#
† Árbol de levas, (IZQ.)	30T	S852	53020938
† Árbol de levas, (DER.)	30T	S854	53021169AA
† Cigüeñal	25T	S861	53020679
† Cadena, (Primario)	35L	C393	53020680
† Cadena, (Secundaria)	53L	C394 1	53020778
† Tensor, (Primario)		9-5423	53020681
† Tensor, (DER. Secundario)		9-5424	53020779
† Tensor, (IZQ. Secundario)		9-5425	53021168AA
† Brazo tensor, (Secundario)		9-5427 1	53020910
† Guía, (Secundaria)		9-5426 1	53020781
† Engrane loco, (Primario)	50T	S863	53021170AA
† engrane loco, (Secundario)	30T	S865	53021021
†Timing Kit		9-0393S	

1 - 2 Requeridos

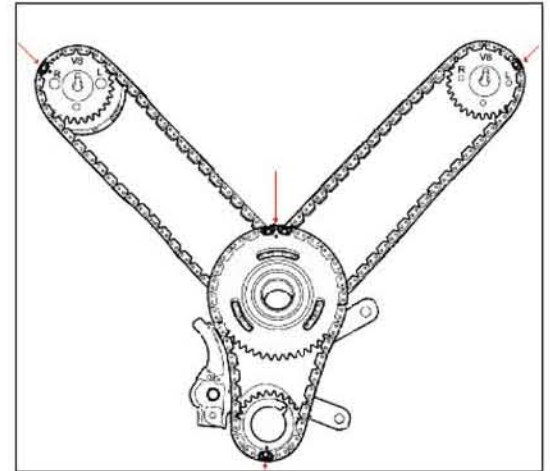

Chrysler

Dakota, Durango, Pickup 2001-03
Jeep Liberty, Grand Cherokee 2002-03

Número de parte
9-0393SA
9-0393SC

3.7-K (226) SOHC V6

Descripción	Número de parte	OE#	
† Árbol de levas, (IZQ.)	26T	S824	53021290AA
† Árbol de levas, (DER.)	26T	S832	53021291AF
† Cigüeñal	25T	S861	53020679
† Cadena, (Secundario)	94L	C194	53021295AA
† Cadena, (Primario)	35L	C393	53020680
† Tensor, (Primario)		9-5423	53020681
† Tensor, (DER.)		9-5454	53021249AA
† Tensor, (IZQ.)		9-5455	53021250AA
† Brazo tensor		9-5456	53021292AB
† Guía, (DER.)		9-5457	53021293AA
† Guía, (IZQ.)		9-5458	53021294AA
† Engrane loco	50T	S863	53021170AA
† Timing Kit		9-0393SA	
• Timing Kit		9-0393SC	

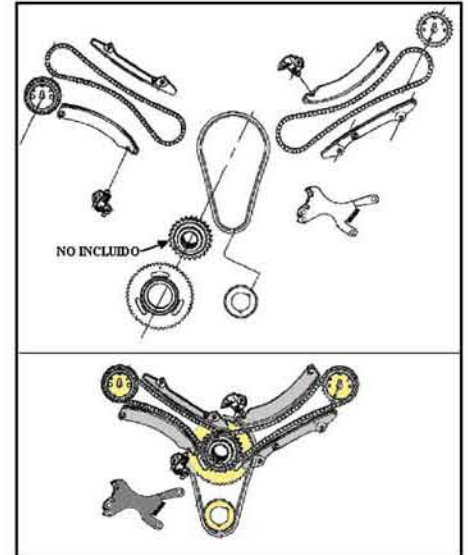

1 - 2 Requeridos

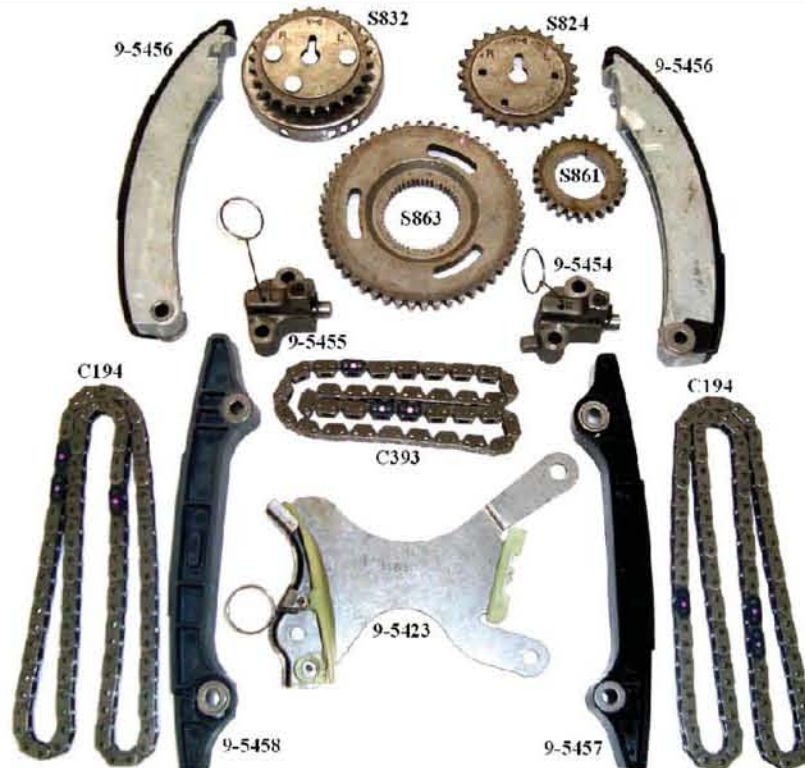



Chrysler

Dakota, Durango, Pickup 2004-07.
Jeep Liberty, Grand Cherokee 2004-07

Número de parte
9-0393SB
9-0393SC

3.7-K(226) SOHC V6

Descripción	Número de parte	OE#	
† Árbol de levas, (IZQ.)	26T	S824	53021290AA
† Árbol de levas, (DER.)	26T	S868	53021291AD
† Cigüeñal	25T	S861	53020679
† Cadena, (Secundario)	94L	C194 †	53021295AA
† Cadena, (Primario)	35L	C393	53020680
† Tensor, (Primario)	9-5423		53020681
† Tensor, (DER.)	9-5454		53021249AA
† Tensor, (IZQ.)	9-5455		53021250AA
† Brazo tensor	9-5456 †		53021292AB
† Guía, (DER.)	9-5457		53021293AA
† Guía, (IZQ.)	9-5458		53021294AA
† Engrane loco	50T	S863	53021170AA
† Timing Kit	9-0393SB		
• Timing Kit	9-0393SC		

1 - 2 Requeridos

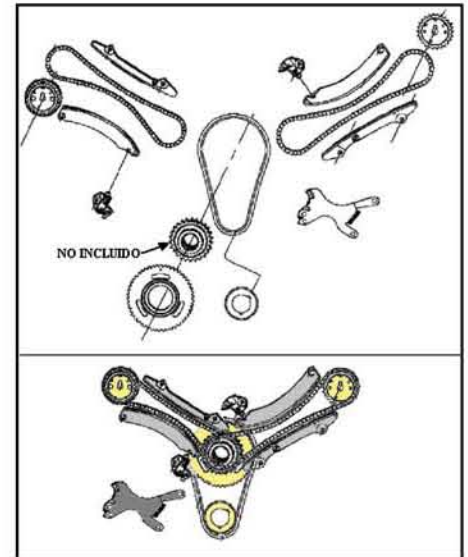

Chrysler

Dakota 2002-06. Durango, Ram, Pickup
2003-06.

Jeep Grand Cherokee 2006-05
Con NGC Target Wheel

Número de parte
9-0393SD

4.7-N, J (287) SOHC V8

Descripción	Número de parte		OE#
† Árbol de levas, (IZQ.)	30T	S852	53020938
† Árbol de levas, (DER.)	30T	S870	53021393AA
† Cigüeñal	25T	S861	53020679
† Cadena, (Primario)	35L	C393	53020680
† Cadena, (Secundario)	53L	C394 1	53020778
† Tensor, (Primario)		9-5423	53020681
† Tensor, (DER. Secundario)		9-5424	53020779
† Tensor, (IZQ. Secundario)		9-5425	53021168AA
† Brazo tensor, (Secundario)		9-5427 1	53020910
† Guía, (Secundario)		9-5426 1	53020781
† Engrane loco, (Primario)	50T	S863	53021170AA
† Engrane loco, (Secundario)	30T	S865	53021021

† Timing Kit

9-0393SD

1 - 2 Requeridos

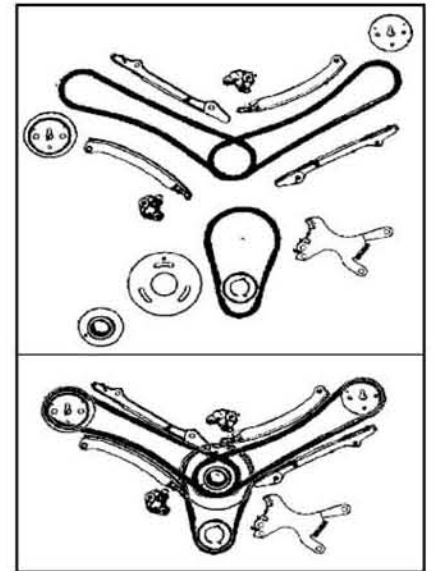



Dodge/Jeep

Dakota, Durango, Ram 1500
(02-06)
Comander, Grand Cherokee
(99-06)
4.7L (285, 287) V8

Número de parte
9-0393SX

DESCRIPCIÓN		PART #	OE #
Cadena (Primaria)	35L	C393	53020680
Cadena (Secundaria)	53L	C394	53020778
Tensor (Primario)		9 5423	53020681
Tensor (Derecho Secundario)		9 5424	53020779
Tensor (Izquierdo Secundario)		9 5425	53021168AA
Brazo tensor (Secundario)		9 5427	53020910
Guía (Secunadaria)		9 5426	53020781



Ford

200/250
(63-83)

Número de parte
C-3026K

DESCRIPCIÓN		PART #	OE #
ARBOL DE LEVAS	38T	S308	D8BZ6256B
CIGUEÑAL	19T	S397	CODZ6306A
CADENA	50L	S351	CODZ6268A



<h1>Ford</h1>	Ford Bronco II, Ranger 1986-92. Mercury 1988-89. Merkur Scorpio 1988-89.	Número de parte 9-4151S C-3075
2.9L -V, T (177) OHV V6		

Descripción		Número de parte	OE#
†• Árbol de levas	38T	S650	E6TZ6256A
†• Cigüeñal	19T	S651	E6TZ6306A
†• Cadena	60L	9-4151	E6TZ6268A
• Tensor		9-5157	E6TZ6K254A
• Guía		9-5187	E6TZ6K297A
† 3 Pc. Set		C-3075	
• Timing Kit		9-4151S	

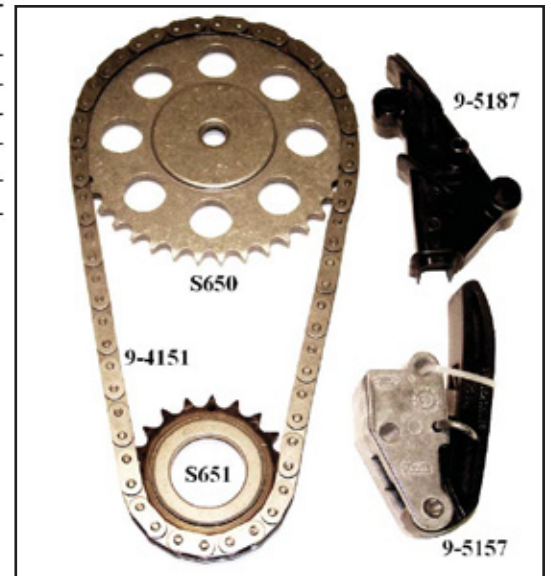

<h1>Ford</h1>	BRONCO V8 (80-88)	Número de parte C-3057K
---------------	------------------------------------	--

DESCRIPCIÓN		PART #	OE #
ARBOL DE LEVAS	42T	S612	E4AZ6256A
CIGUEÑAL	21T	S531	E0AZ6306A
CADENA	58L	C163	E0AZ6268A





Ford/Mazda

Probe;
626, MX6;
L4 2.2L (1988-1992)

Número de parte
BK-134

DESCRIPTION		PART #	OE #
Correa	110T	B134	E92Z6268A
Tensor		9-5166	E92Z6K254A
Rueda Loca		9-5215	E92Z6M250A



Ford/Mercury

CONTOUR, TAURUS,
MONDEO;
MYSTIQUE, SABLE (96-00)

Número de parte
9-0392S

DESCRIPCIÓN		PART #	OE #
Cigueñal	18T	S833	F8RZ6306AA
Cadena	122L	C392	F6DZ6268CA
Tensor		9-5418	F6DZ6L266BA
Brazo Tensor		9-5421	F6RZ6L253BA
Guía (Derecha)		9-5419	F8RZ6K297BA
Guía (Izquierda)		9-5420	F8RZ6K297AA

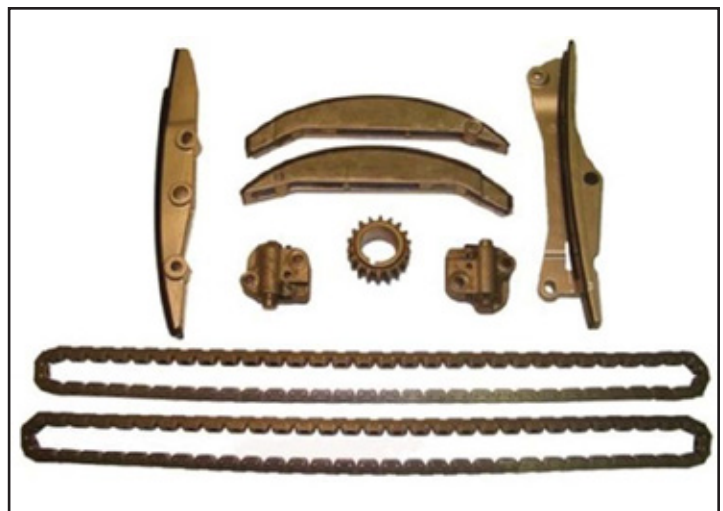

Ford/Mercury

Contour;
Mystique;
L4 2.0L 1989cc (1995-1997)

Número de parte
BK-258

DESCRIPCIÓN		PART #	OE #
Correa	131T	B258	F5RZ6268A
Tensor		9-5390	F5RZ6K254A
Tensor Auxiliar, Rueda Loca (Superior)		9-5409	F5RZ6M250A
Tensor Auxiliar, Rueda Loca (Inferior)		9-5410	F5RZ6M250B



Ford/Mercury

Escort;
Tracer;
L4 1.9L (1991-1996)

Número de parte
BK-194

DESCRIPCIÓN		PART #	OE #
Correa	97T	B194	FICZ6268A
Tensor		9-5475	2M5Z6K264AAA





Ford

Contour, Escort, Focus, Cougar
Mistique 1998-1999

Número de parte
BK294

2.0L -3, 5, Z (1989CC) DOHC (ZTEC Engine)

Descripción		Número de parte	OE#
Banda de distribución	129T	B294	F8CZ6268AA
Tensor Auxiliar à Rueda Loca		9-5476	F8CZ6M250AA
Tensor Auxiliar à Rueda Loca		9-5477	X54Z6M250BA
Tensor Automático de Banda		9-5479	F8CZ6K254AA
Kit de Banda		BK294	March28, 1999 & older



Ford

Contour, Escort, Focus, Escape, Cougar
Mistique, Mazda Tribute 1999-2004

Número de parte
BK294A

2.0L -3, 5, Z (1989CC) DOHC (ZTEC Engine)

Descripción		Número de parte	OE#
Banda de distribución	129T	B294	F8CZ6268AA
Tensor Auxiliar à Rueda Loca		9-5476	F8CZ6M250AA
Tensor Auxiliar à Rueda Loca		9-5478	YS4Z6M250BA
Tensor Automático de Banda		9-5479	F8CZ6K254AA
Kit de Banda		BK294A	March29, 1999 & newer



Ford

Crown Victoria, Cougar, Thunderbird
Grand Marquis. 1994-95
Lincoln Town Car 1994-95

Número de parte
9-0387S

4.6L -W, 9 (281) SOHC V8

Descripción	Número de parte	OE#	
† Árbol de levas, (IZQ.)	42T	S764T	F8AZ6256BA
† Árbol de levas, (DER.)	42T	S766T	F8AZ6256AA
† Cigüeñal	21T	S843	XL3Z6306BA
† Cadena	116L	C387 1	5W7Z6268AA
† Tensor, (IZQ.)		9-5371 2	F5AZ6L266AA
† Tensor, (DER.)		9-5372 3	F5AZ6L266BA
† Brazo tensor, (DER.)		9-5340	1L2Z6L253BA
† Brazo tensor, (IZQ.)		9-5341	1L2Z6L253AA
† Guía, (DER.)		9-5319	F3AZ6K297A
† Guía, (IZQ.)		9-5320	F3AZ6K297B

†Timing Kit

9-0387S

1 - 2 Requeridos

2 - Incluye F5AZ6C275AA Adaptor Plate y Tensor F6AZ6L266CA

3 - Incluye F5AZ6C275AA Adaptor Plate y Tensor F5AZ6L266BA

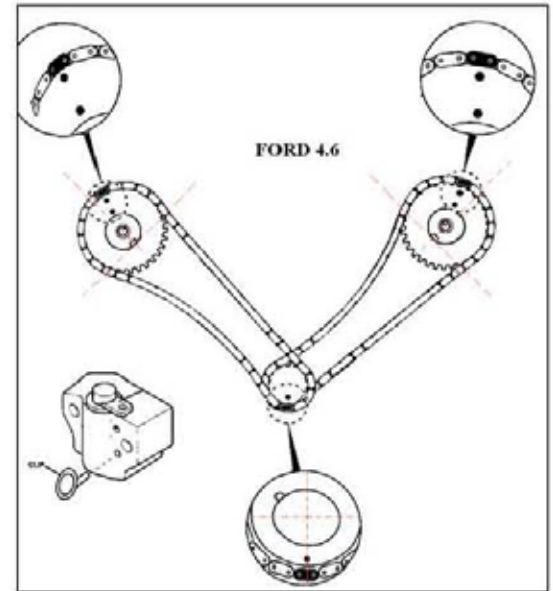



Ford

Crown Victoria **2000-08.**
 E150, Expedition, Explorer, F150, F250
2002-07.
 Lincoln Town Car **2002-07.**
 Grand Marquis, Marauder **2004-07**

Número de parte
9-0387SG

4 . 6L -V, W, 6, 9 (281) SOHC V8

Descripción	Número de parte	OE#
† Árbol de levas , (IZQ.)	42T S764T	F8AZ6256BA
† Árbol de levas, (DER.)	42T S766T	F8AZ6256AA
† Cigüeñal	21T S869	XL3Z6306AA
† Cadena	116L C387 1	5W7Z6268AA
† Tensor , (IZQ.)	9-5432	XL1Z6L266AA
† Tensor, (DER.)	9-5433	1L3Z6L266AA
† Brazo tensor, (DER.)	9-5340	1L2Z6L253BA
† Brazo tensor, (IZQ.)	9-5341	1L2Z6L253AA
† Guía, (DER.)	9-5428	1L2Z6K297AA
† Guía , (IZQ.)	9-5429	4R3Z6B274BA
† Timing Kit	9-0387SG	
• Timing Kit (Sin Sprockets)	9-0387SGX	

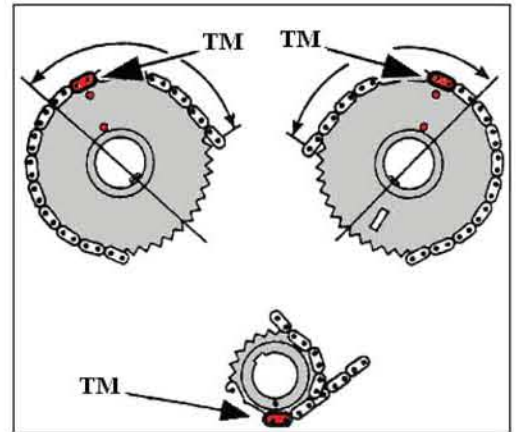

1 - 2 Requeridos

FROM NOVEMBER 2002

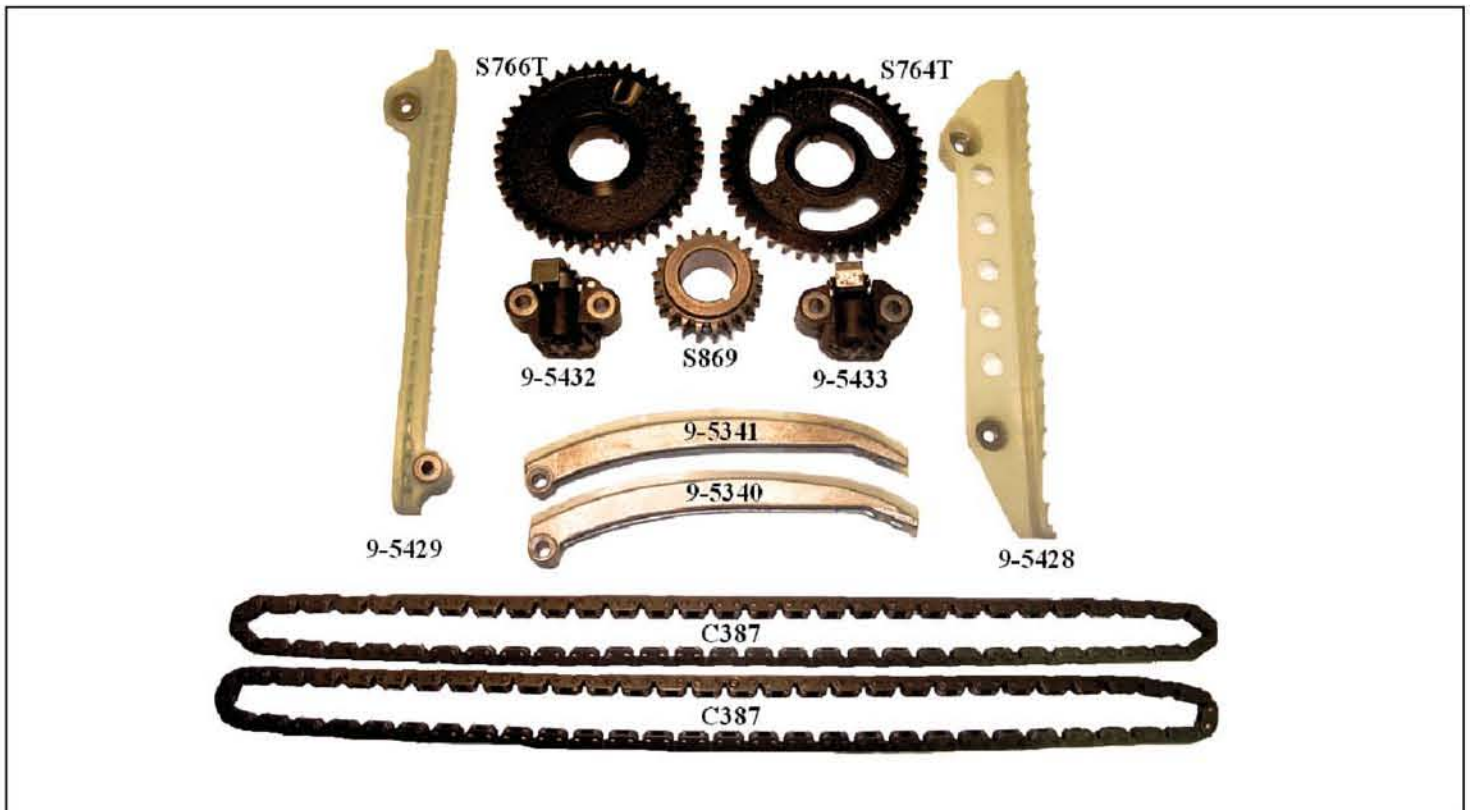

Ford

Fiesta, KA, IKON, Courier, Ecosport
1999-2006

Número de parte
9-4800S

1.6L 4 Cil. SOHC (ZETEC ROCAM Eng.)

Descripción		Número de parte	OE#
† Cadena	116L	9-4800	XS6E6268AA
† Guía IZQ.		9-9405	XS6E6M255AA
† Guía DER.		9-9406	XS6E6M256AD
† Tensor		9-9407	XS6E6L266AE
† Engrane de cigüeñal	19T	S1400	XS6E6306AA
† Engrane de Árbol	38T	S1401	XS6E6256AB
† Kit de tiempo		9-4800S	

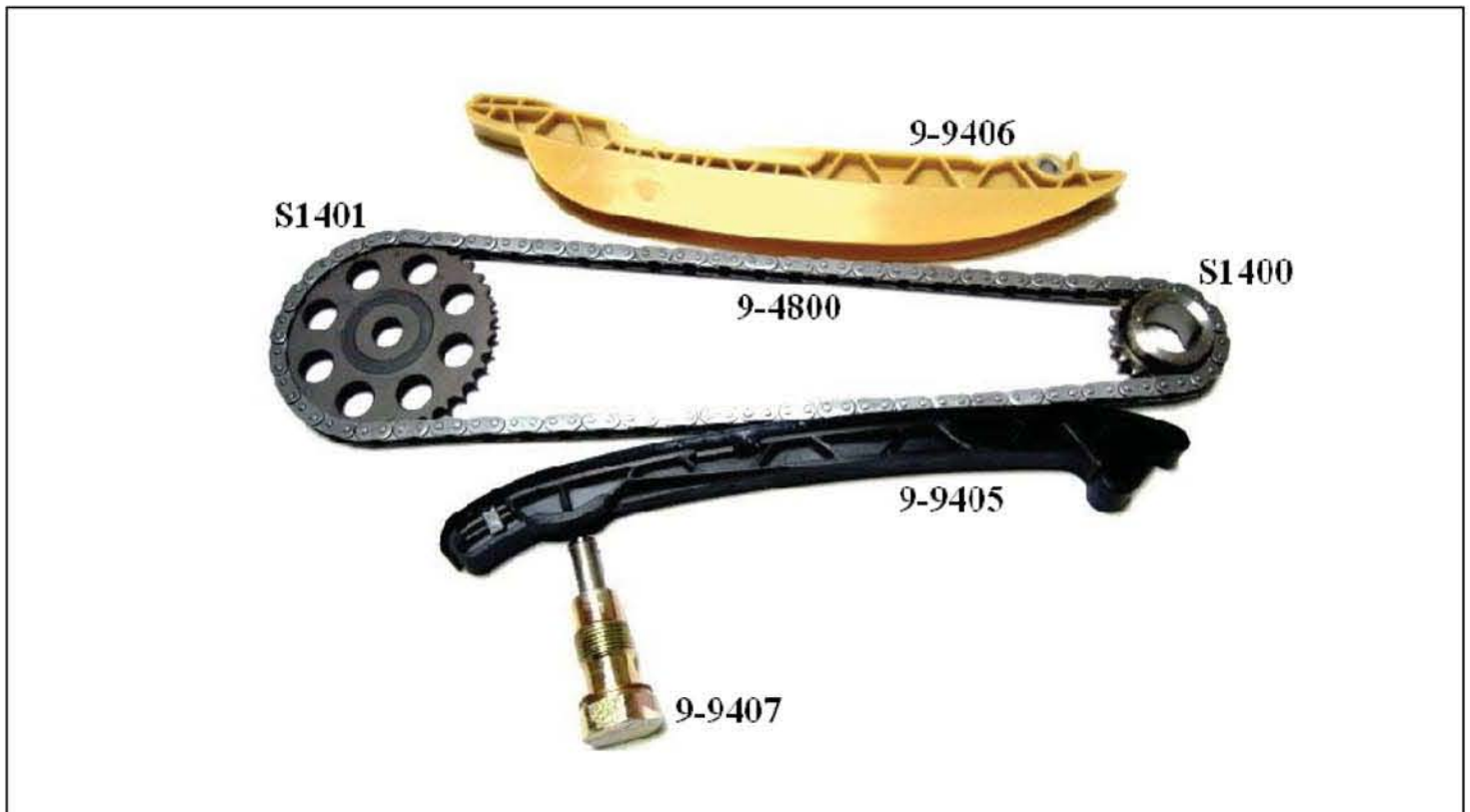
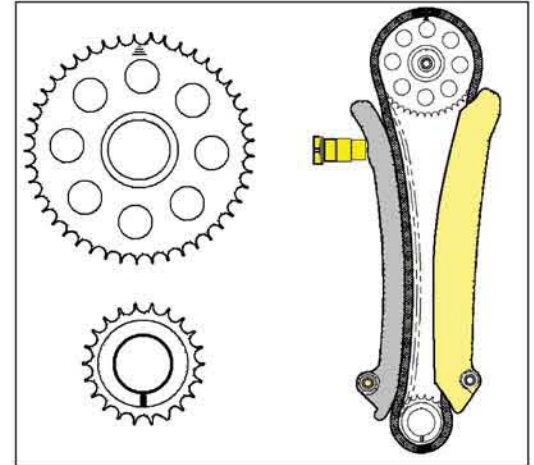



Ford

Ranger 2001-08,
Mazda B2300 2001-08

9-0705S

2.3L (2300cc) DOHC 4 CIL.

Descripción	Número de parte	OE#	
† Árbol de levas	38T	S898T 1	LF0112425
† Cigüeñal	19T	S891	LF0111316
† Cadena	138L	C705F	L30112201
† Tensor		9-5514	LF0112500A
† Tensor bomba de aceite		9-5516	LF0114500B
† Brazo tensor		9-5513	L30112671
† Guía		9-5515	LF30112614
† Guía		9-5517	LF0114614
† Cadena bomba de aceite	54L	C706F	LF0114151
† Sprocket bomba de aceite	24T	S893	LF0114143
† Timing Kit		9-0705S	

1 - 2 Requeridos

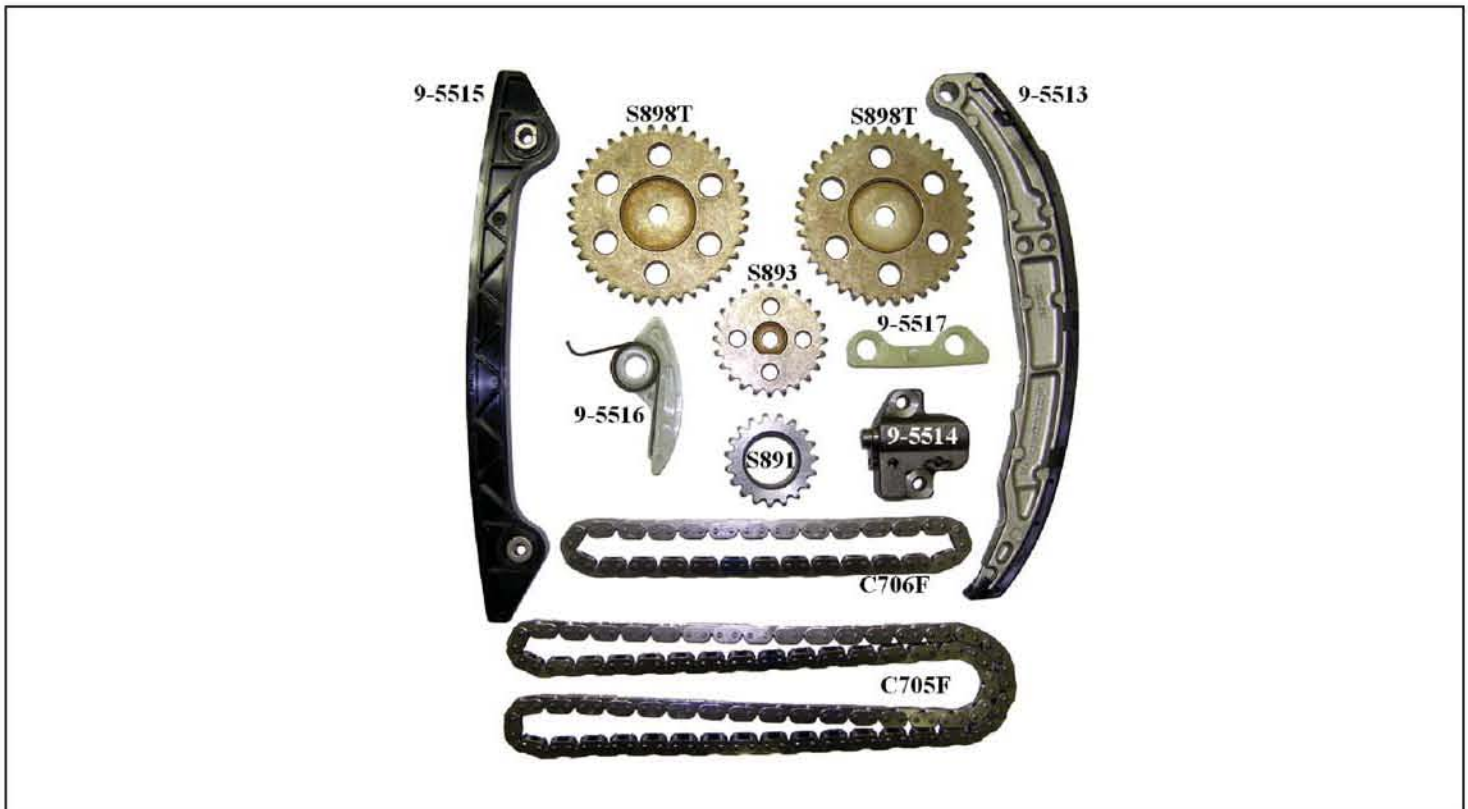
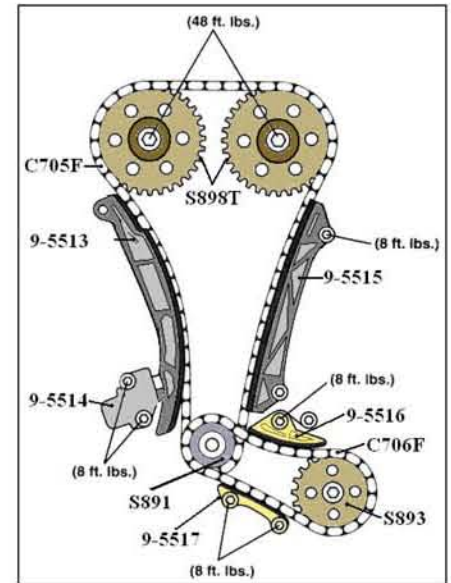

Ford

Ford Ranger, Explorer 1997-06.
 Land Rover 1997-08.
 Mazda B4000 2001-06.
 Mercury Mountaineer 1998-06.

Número de parte
9-0398S
9-0398SA
9-0701SA

4.0L -E, K (245) V6 SOHC

DESCRIPCIÓN	#PARTE
Timing Kit , (Complete) 2WD	9-0398SA 1
1 - 9-0398SA Contiene Cassettes RH & LH ,cadena Primaria, Cadena, Tensores (2), Guía Primaria, tensor de hoja primario y arandelas(2)	
Timing Kit , (Complete) 4WD	9-0398S 2
2 - 9-0398S contiene todos los componentes de: 9-0701S & 9-0701SA	
Timing Kit , (Bal. Shaft) 4WD	9-0701SA 3
3 - 9-0701SA contiene cadena de Bal Shaft, guía y tensor.	

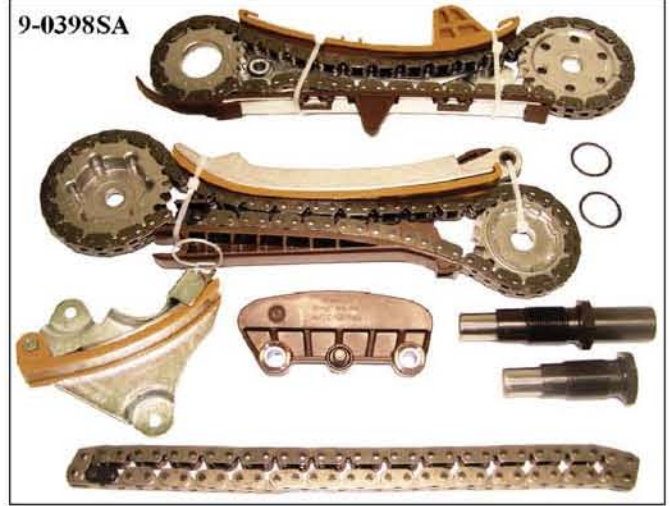
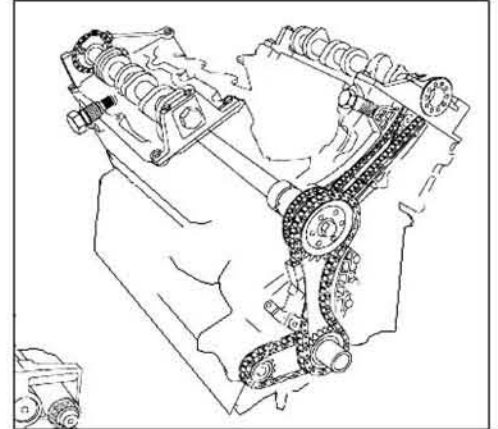



Ford

Ford Ranger, Explorer, Aerostar
1990-94.
Mazda Navajo, B4000 1991-94

Número de parte
9-4172S
C-3078

4.0L -X(244) OHV V6

Descripción		Número de parte	OE#
†• Árbol de levas	38T	S650	E6TZ6256A
†• Cigüeñal	19T	S651	E6TZ6306A
†• Cadena	64L	9-4172	F5TZ6268A
• Tensor		9-5157	F1TZ6K254A
• Guía		9-5261	F0TZ6K297A
† 3 Pc. Set		C-3078	
• Timing Kit		9-4172S	

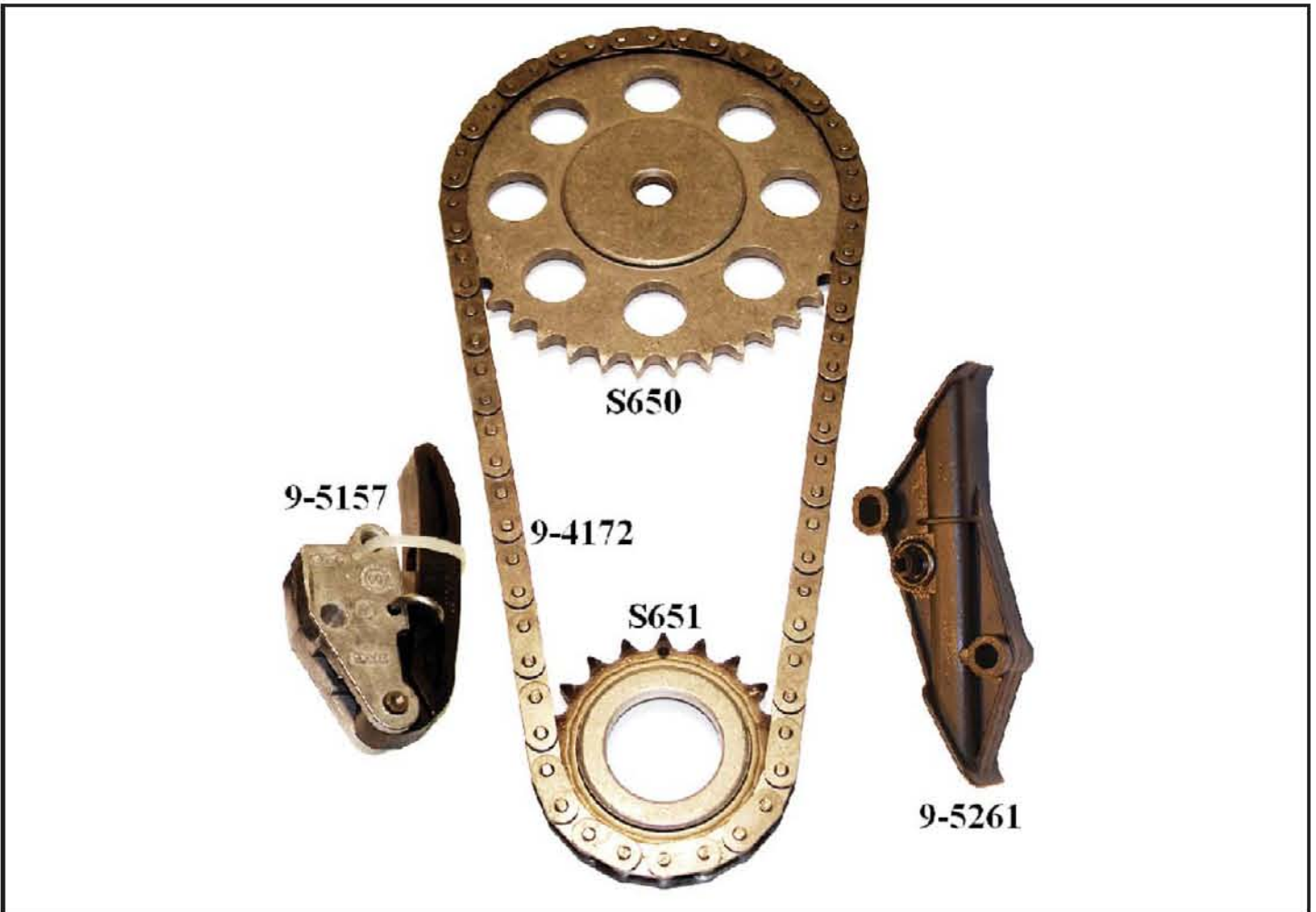

Ford

Ford Ranger, Explorer, Aerostar
1995-02.
Mazda Navajo, B4000 1995-00

Número de parte
9-4172SA
C-3098

4.0L -X (244) OHV V6

Descripción		Número de parte	OE#
† Árbol de levas	38T	S650	E6TZ6256A
† Cigüeñal	19T	S821	F6TZ6306BA
† Cadena	64L	9-4172	F5TZ6268A
• Tensor		9-5345	F4TZ6K254A
• Guía		9-5261	F0TZ6K297A
† 3 Pc. Set		C-3098	
• Timing Kit		9-4172SA	

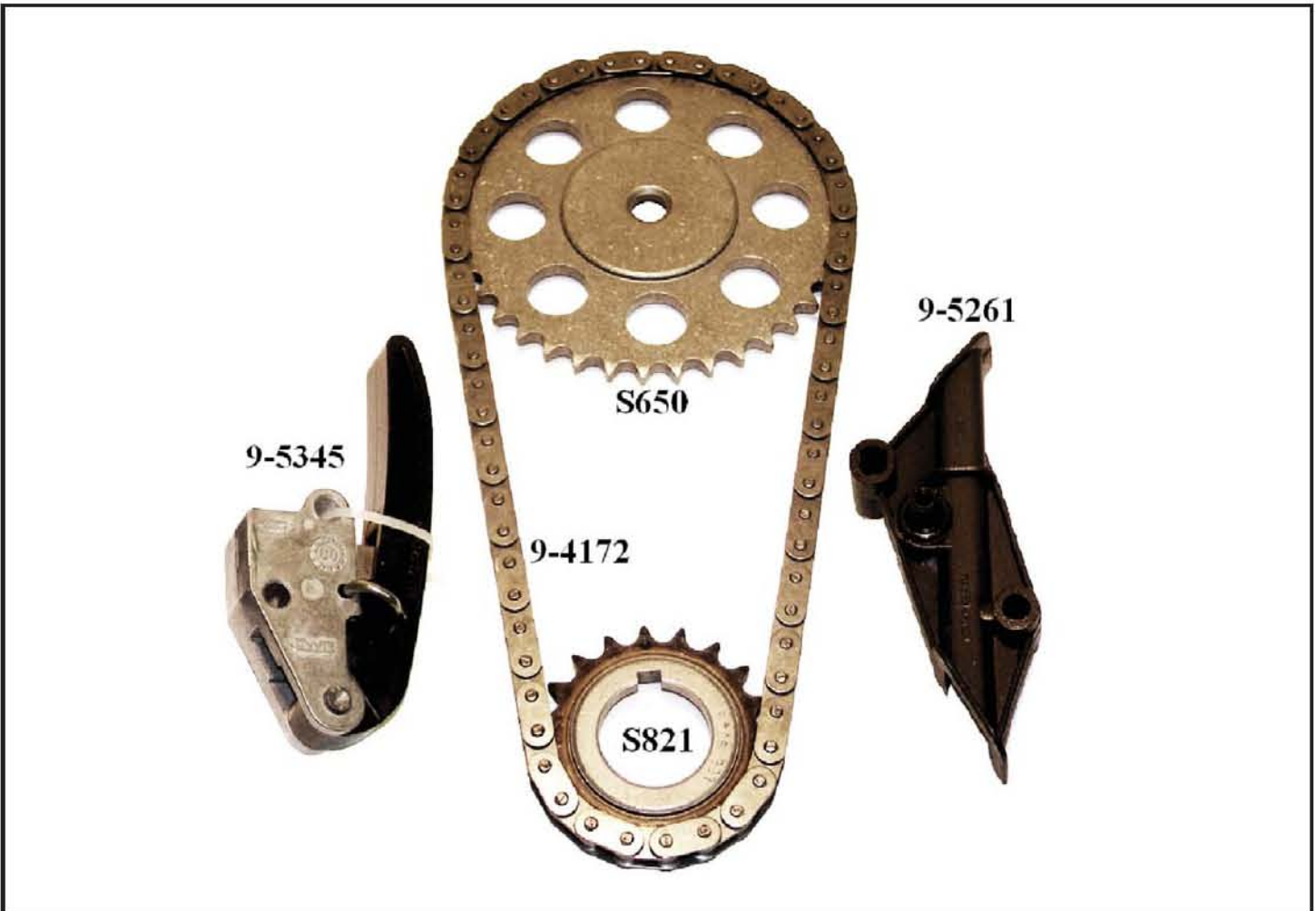



Ford

Mustang GT 1996-98. Crown Victoria
1996-99. E150, Expedition, Explorer,
F150, F250 1997-00. Cougar, Grand
Marquis 1996-99.
Lincoln Town Car 1996-00.

Número de parte
9-0387SA

4.6L -X, W, 9 (281) SOHC V8 ROMEO Eng.

Descripción	Número de parte		OE#
† Árbol de levas, (IZQ.)	42T	S764T	F8AZ6256BA
† Árbol de levas, (DER.)	42T	S766T	F8AZ6256AA
† Cigüeñal	21T	S843	XL3Z6306BA
† Cadena	116L	C387 ¹	5W7Z6268AA
† • Tensor, (IZQ.)		9-5338	F6AZ6L266CA
† • Tensor, (DER.)		9-5339	F6AZ6L266DA
† • Brazo tensor, (DER.)		9-5340	1L2Z6L253BA
† • Brazo tensor, (IZQ.)		9-5341	1L2Z6L253AA
† • Guía, (DER.)		9-5319	F3AZ6K297A
† • Guía, (IZQ.)		9-5320	F3AZ6K297B
† Timing Kit		9-0387SA	
• Timing Kit (Sin Sprockets)		9-0387SAX	

1 - 2 Requeridos

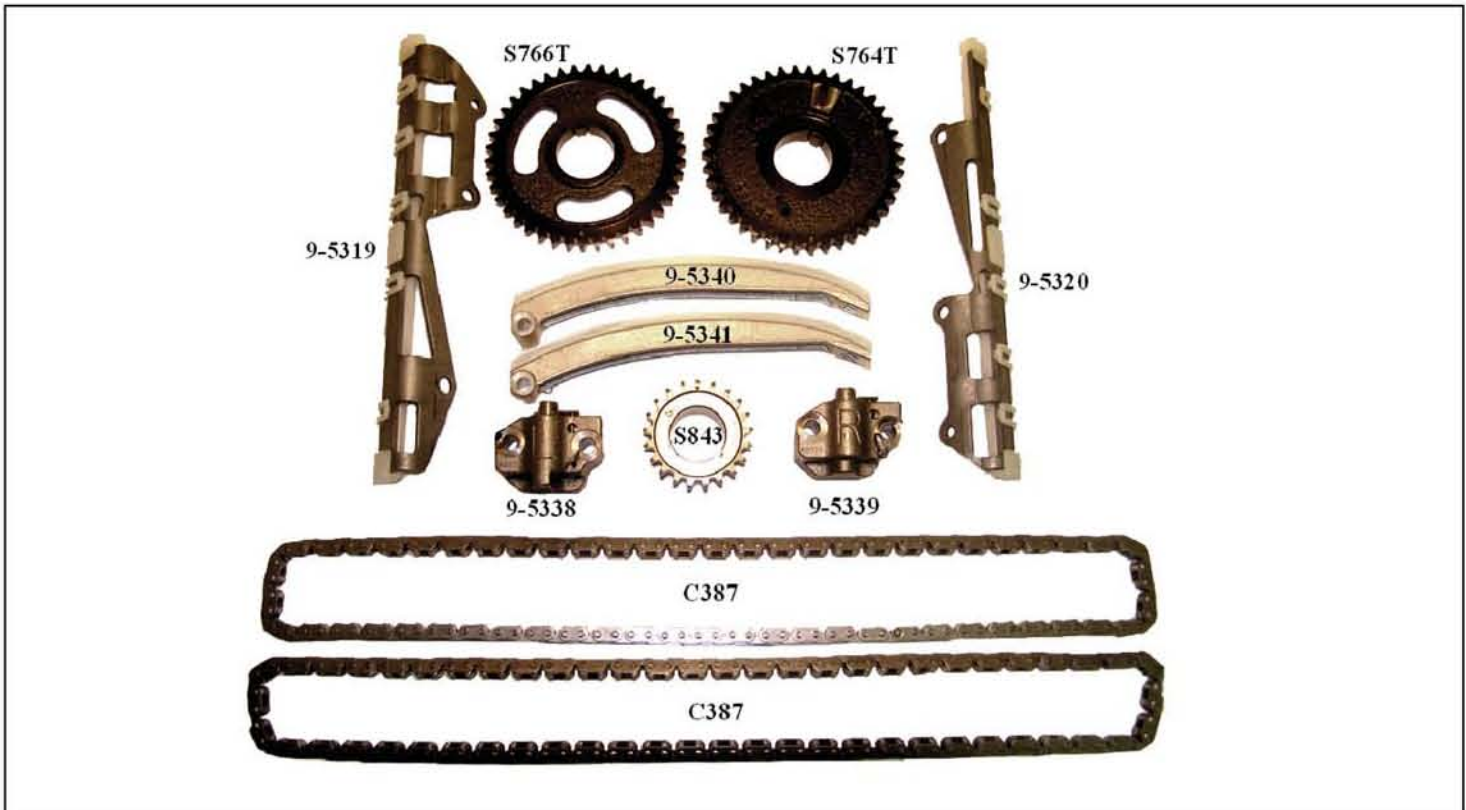
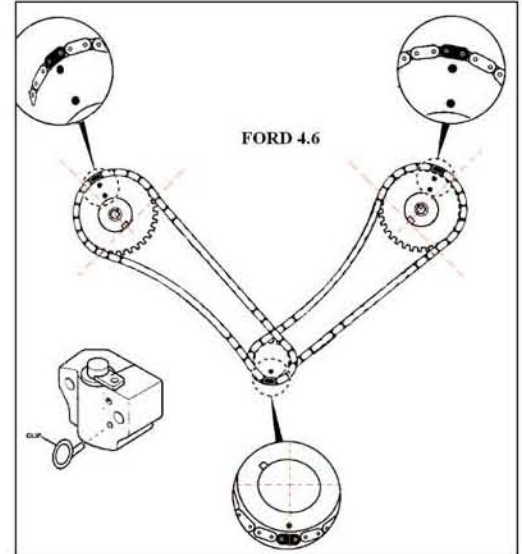

Ford

Mustang GT 1999-00
E150, Expedition, F150, F250 1997-00

Número de parte
9-0387SH

4.6L -6, X(281) SOHC V8 (Windsor Engine)

Descripción	Número de parte		OE#
† Árbol de levas , (L.H.)	42T	S764T	F8AZ6256BA
† Árbol de levas , (R.H.)	42T	S766T	F8AZ6256AA
† Cigüeñal	21T	S843	F3AZ6306A
†• Cadena	116L	C387 1	5W7Z6268AA
†• Tensor , (L.H.)		9-5338	F6AZ6L266CA
†• Tensor , (R.H.)		9-5339	F6AZ6L266DA
†• Brazo Tensor, (R.H.)		9-5340	1L2Z6L253BA
†• Brazo Tensor, (L.H.)		9-5341	1L2Z6L253AA
†• Guía , (R.H.)		9-5428	1L2Z6K297AA
†• Guía , (L.H.)		9-5429	4R3Z6B274BA
† Timing Kit		9-0387SH	
• Timing Kit , (Sin Sprockets)		9-0387SHX	

1 - 2 Required

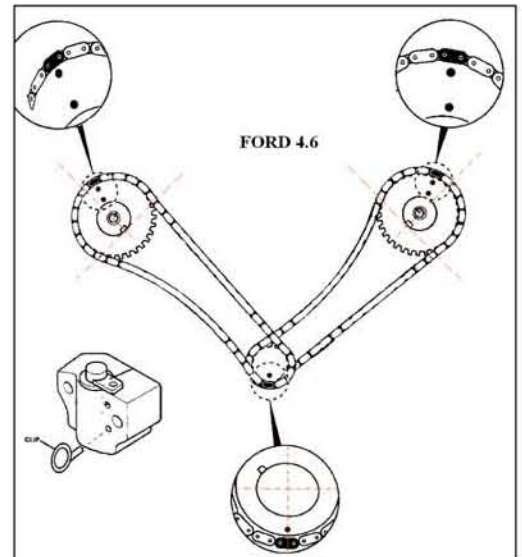



Ford

Mustang GT 2001-04.
E150, Expedition, F150, F250 2001-02
(To October 2002).
Lincoln Town Car 2001-02 (To October 02).
Mercury Grand Marquis 2000-01

Número de parte
9-0387SJ

4.6L -6, W, X (281) SOHC V8

Descripción	Número de parte	OE#
• Árbol de levas , (L.H.)	42T S764T	F8AZ6256BA
• Árbol de levas , (R.H.)	42T S766T	F8AZ6256AA
• Cigüeñal	21T S869	XL3Z6306AA
† Cadena	116L C387 1	5W7Z6268AA
† Tensor , (L.H.)	9-5338	F6AZ6L266CA
† Tensor , (R.H.)	9-5339	F6AZ6L266DA
† Brazo Tensor, (R.H.)	9-5340	1L2Z6L253BA
† Brazo Tensor, (L.H.)	9-5341	1L2Z6L253AA
† Guía , (R.H.)	9-5428	1L2Z6K297AA
† Guía , (L.H.)	9-5429	4R3Z6B274BA
† Timing Kit (Sin Sprockets)	9-0387SHX	
• Timing Kit	9-0387SJ	

1 - 2 Required

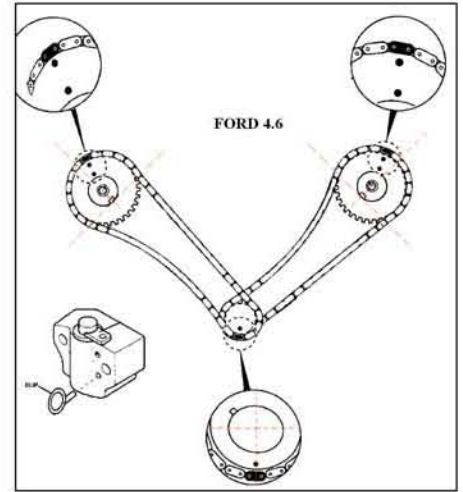

Ford

Mustang Mach I 2003-04,
Lincoln Aviator 2003-05

Número de parte
9-0387SF

4.6L -R(281) DOHC V8 (32 Válvulas)

Descripción	Número de parte		OE#
† Árbol de levas, (IZQ.)	42T	S764T	F3AZ6256A
† Árbol de levas, (DER.)	42T	S766T	F7LZ6256AA
† Árbol de levas, (Secundario)	20T	S790A ¹	F8ZZ6256AA
† Cigüeñal	21T	S869	XL3Z6306AA
† Cadena, (Secundario)	44L	C189 ²	F3LY6268B
† Cadena, (Primario)	116L	C387 ²	5W7Z6268AA
† Tensor, (Secundario, DER.)		9-5394	F7LZ6K254AA
† Tensor, (Secundario, IZQ.)		9-5395	F7LZ6K254BA
† Tensor, (Primario, IZQ.)		9-5432	XL1Z6L266AA
† Tensor, (Primario, DER.)		9-5433	1L3Z6L266AA
† Brazo tensor, (IZQ.)		9-5462	1R3Z6L253AA
† Brazo tensor, (DER.)		9-5463	1R3Z6L253BA
† Guía, (DER.)		9-5461	1R3Z6M256AA
† Guía, (IZQ.)		9-5464	2C5Z6K297AA
† Timing Kit		9-0387SF	

1 - Requiere 4

2 - 2 Requeridos

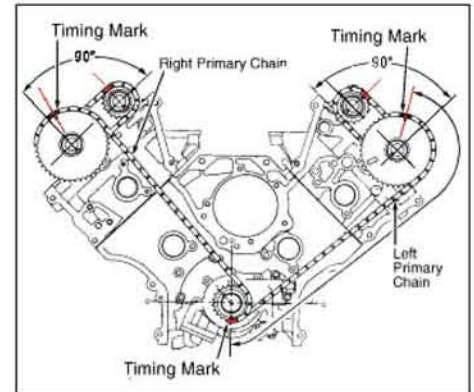



<h1>Ford</h1>	GT "40", Falcon 1998-00 Lincoln Blackwood, Navigator 1998-00	Número de parte 9-0391SC
5.4L -A,R(330) DOHC V8 (32 Válvulas)		

Descripción	Número de parte	OE#
† Árbol de levas , (Secundario)	20T S790A 1	F8ZZ6256AA
† Cigüeñal	21T S843	F3AZ6306A
† Cadena , (Secundario)	44L C189 2	F3LY6268B
† Cadena , (Primario)	116L C391 2	5L3Z6268A
† Tensor, (Primario IZQ.)	9-5338	F6AZ6L266CA
† Tensor, (Primario DER.)	9-5339	F6AZ6L266DA
† Tensor, (Secundario DER.)	9-5394	F7LZ6K254AA
† Tensor, (Secundario IZQ.)	9-5395	F7LZ6K254BA
† Brazo tensor	9-5391 2	XL1Z6K255AA
† Guía , (IZQ.)	9-5392	F3LY6K297A
† Guía, (DER.)	9-5393	1R3Z6M256AA
† Timing Kit	9-0391SC	

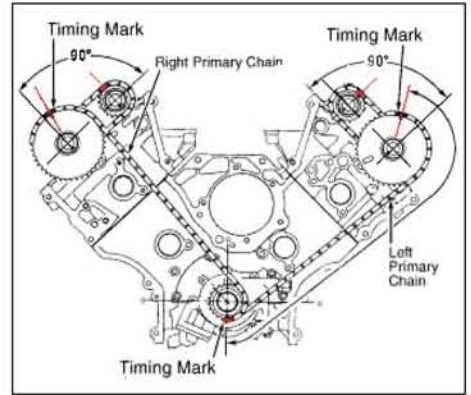

1 - Requiere 4
2 - 2 Requeridos

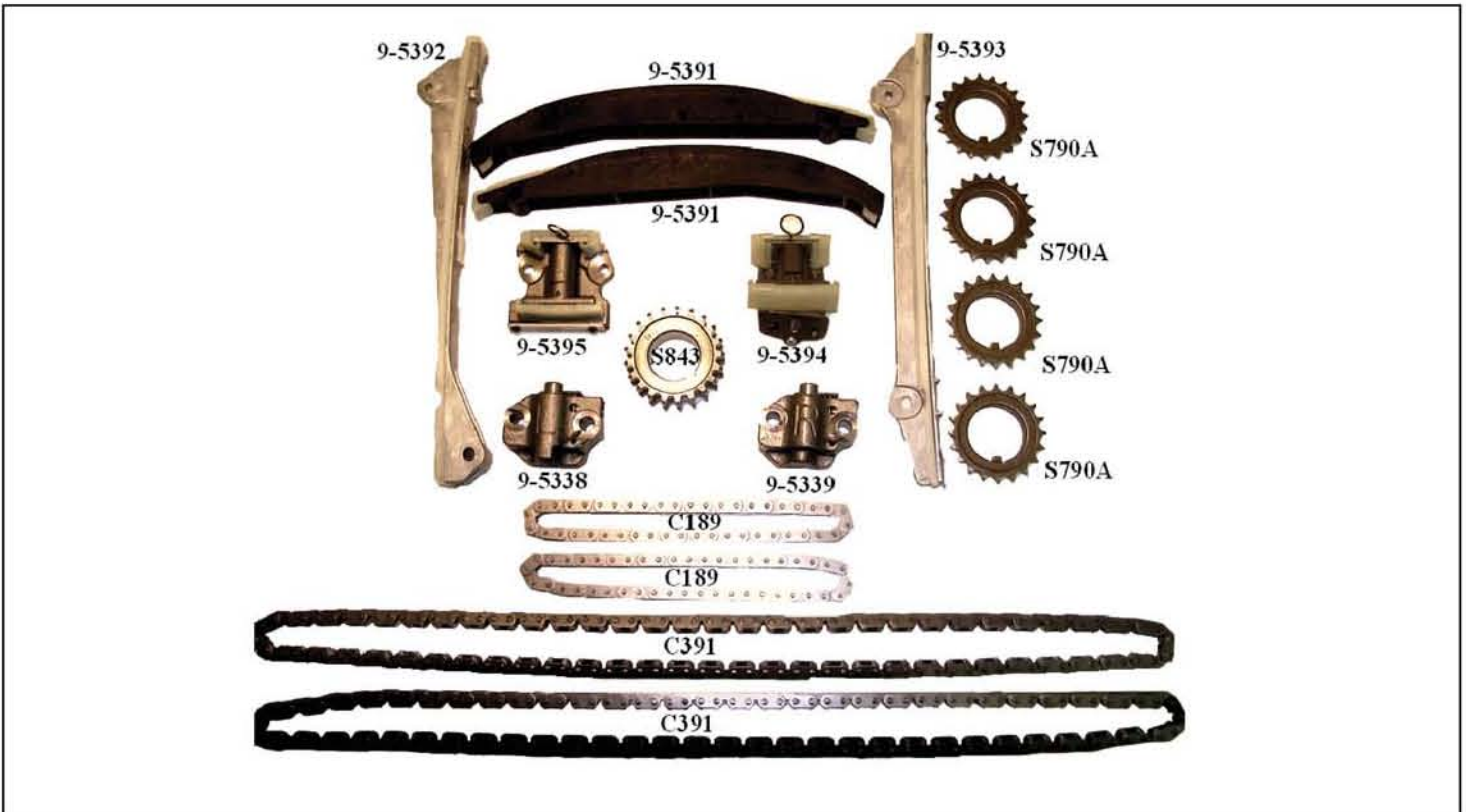

Ford

GT "40", Falcon 2001-02.
Lincoln Blackwood, Navigator
2001-02

Número de parte
9-0391SD

5.4L -A,R(330) DOHC V8 (32 Válvulas)

Descripción	Número de parte	OE#	
† Árbol de levas , (Secundario)	20T	S790A 1	F8ZZ6256AA
† Cigüeñal	21T	S869	XL3Z6306AA
† Cadena , (Secundario)	44L	C189 2	F3LY6268B
† Cadena , (Primario)	116L	C391 2	5L3Z6268A
† Tensor, (Primario IZQ.)		9-5338	F6AZ6L266CA
† Tensor, (Primario DER.)		9-5339	F6AZ6L266DA
† Tensor, (Secundario DER.)		9-5394	F7LZ6K254AA
† Tensor, (Secundario IZQ.)		9-5395	F7LZ6K254BA
† Brazo tensor		9-5391 2	XL1Z6K255AA
† Guía , (IZQ.)		9-5392	F3LY6K297A
† Guía, (DER.)		9-5393	1R3Z6M256AA
† Timing Kit		9-0391SD	

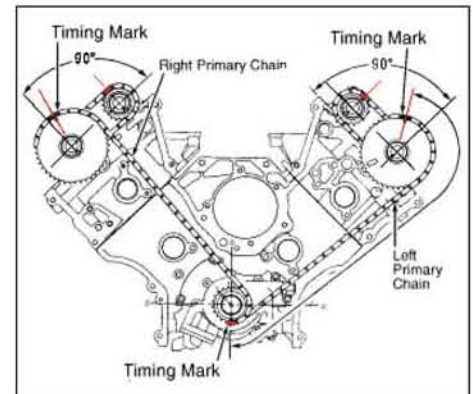

- 1 - Requiere 4
- 2 - 2 Requeridos





Ford

GT "40", Falcon 2003-04.
Lincoln Blackwood, Navigator
2003-04

Número de parte
9-0391SE

5.4L -A,R(330) DOHC V8 (32 Válvulas)

Descripción	Número de parte	OE#
† Árbol de levas , (Secundario)	20T S790A 1	F8ZZ6256AA
† Cigüeñal	21T S869	XL3Z6306AA
† Cadena , (Secundario)	44L C189 2	F3LY6268B
† Cadena , (Primario)	116L C391 2	5L3Z6268A
† Tensor, (Secundario DER.)	9-5394	F7LZ6K254AA
† Tensor, (Secundario IZQ.)	9-5395	F7LZ6K254BA
† Tensor , (IZQ.)	9-5432	XL1Z6L266AA
† Tensor, (DER.)	9-5433	1L3Z6L266AA
† Brazo tensor	9-5391 2	XL1Z6K255AA
† Guía , (IZQ.)	9-5392	F3LY6K297A
† Guía, (DER.)	9-5393	1R3Z6M256AA
† Timing Kit	9-0391SE	

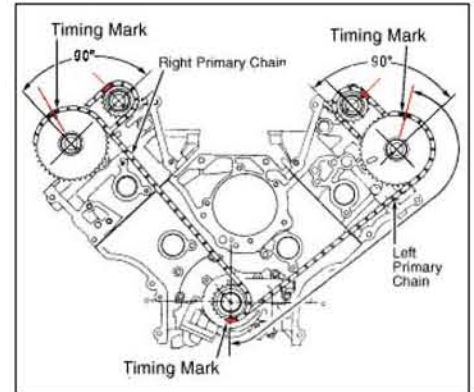

1 - Requiere 4
2 - 2 Requeridos

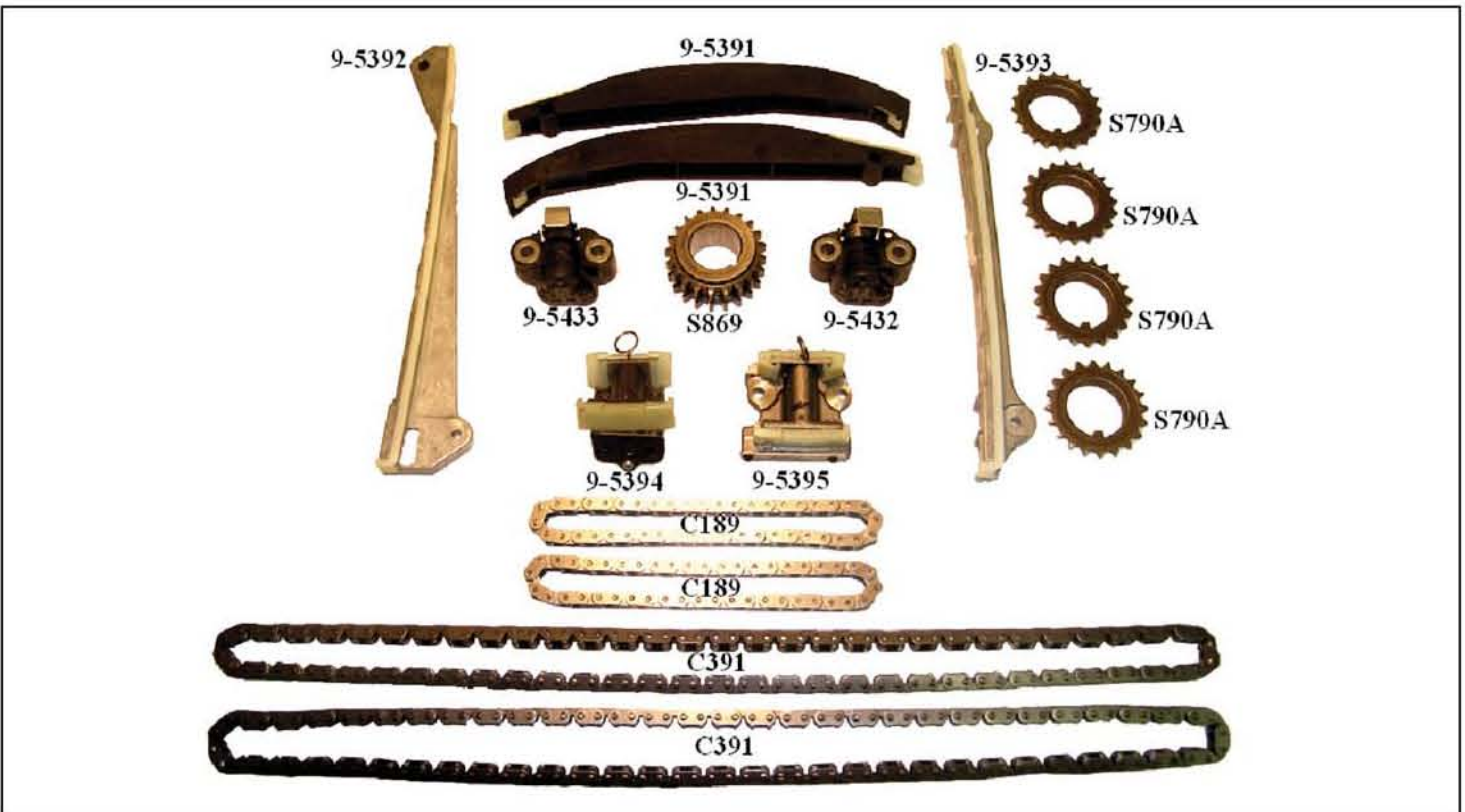

Ford

Explorer, Sport Trac
2006-07

Número de parte
9-0387SK

4.6-8 (281) SOHC V8 (24 Válvulas)

Descripción	Número de parte		OE#
• Cigüeñal	21T	S869	XL3Z6306AA
†• Cadena	116L	C387 1	5W7Z6268AA
†• Tensor , (L.H.)		9-5432	XL1Z6L266AA
†• Tensor , (R.H.)		9-5433	1L3Z6L266AA
†• Brazo Tensor, (R.H.)		9-5340	1L2Z6L253BA
†• Brazo Tensor, (L.H.)		9-5341	1L2Z6L253AA
†• Guía , (R.H.)		9-5428	1L2Z6K297AA
†• Guía , (L.H.)		9-5429	4R3Z6B274BA
† Timing Kit (Sin Sprockets)		9-0387SGX	
• Timing Kit		9-0387SK	

1 - 2 Required

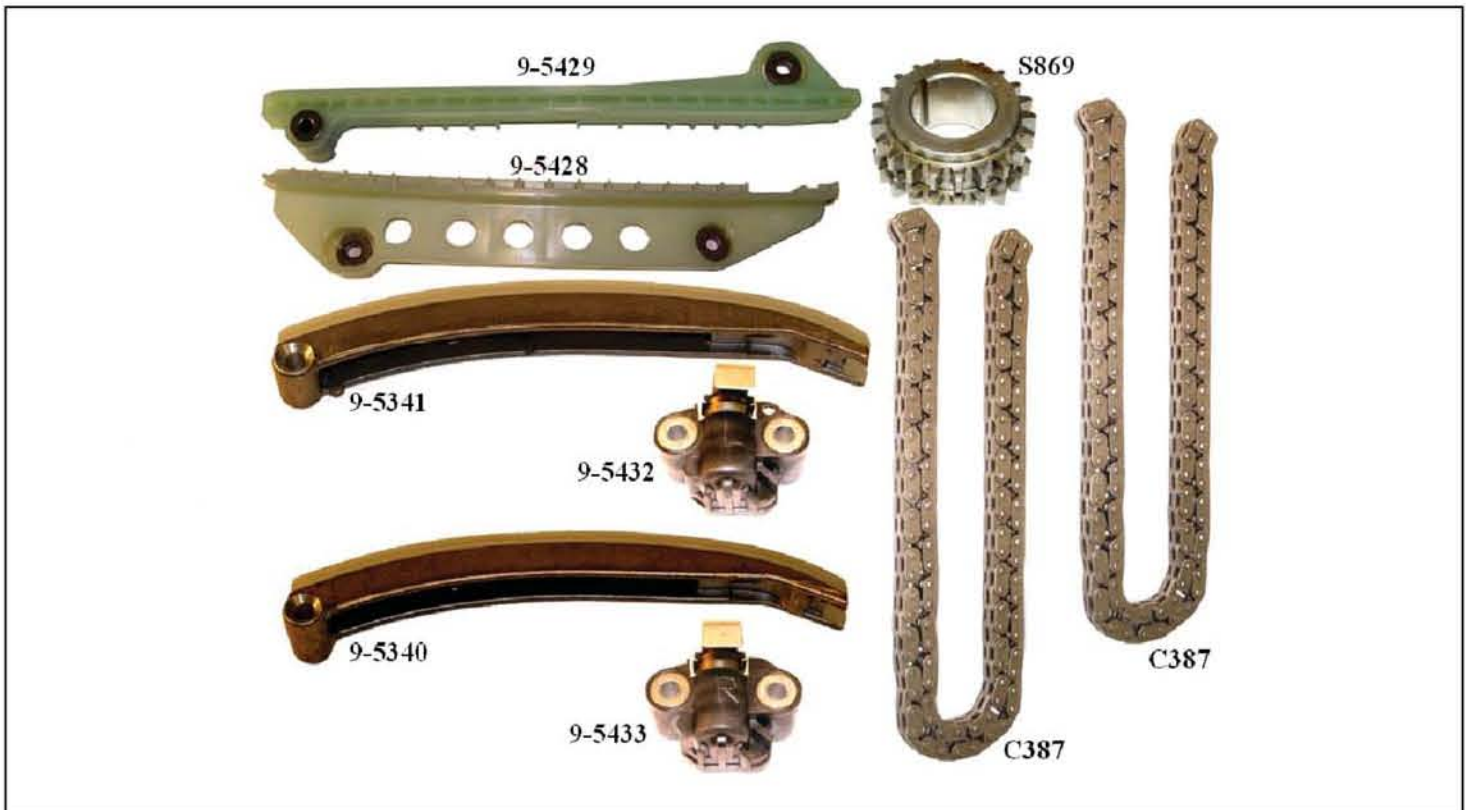



<h1>Ford</h1>	E Super Duty, E-150 E-250 E-350 Econoline, Excursion, Expedition, F-150 F-250 PICKUP 1997-2000	Número de parte 9-0391S
	5.4L -L, M, Z, 3 (330) V8	

Descripción		Número de parte	OE#
† Cigüeñal	21T	S843	F3AZ6306A
† • Cadena	122L	C391	5L3Z6268A
† • Tensor, (IZQ.)		9-5338	F6AZ6L266CA
† • Tensor, (DER.)		9-5339	F6AZ6L266DA
† • Brazo tensor, (DER.)		9-5396	F85Z6M274AA
† • Brazo tensor, (IZQ.)		9-5397	F85Z6K255AA
† • Guía, (DER.)		9-5430	2L1Z6K297AA
† • Guía, (IZQ.)		9-5431	4L3Z6M256AA
† Timing Kit		9-0391S	
• Timing Kit (Sin Sprockets)		9-0391SX	

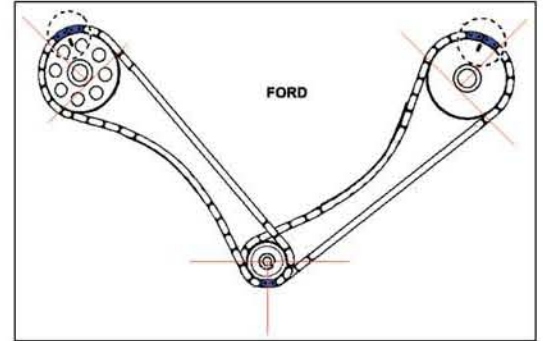

1 - 2 Requeridos

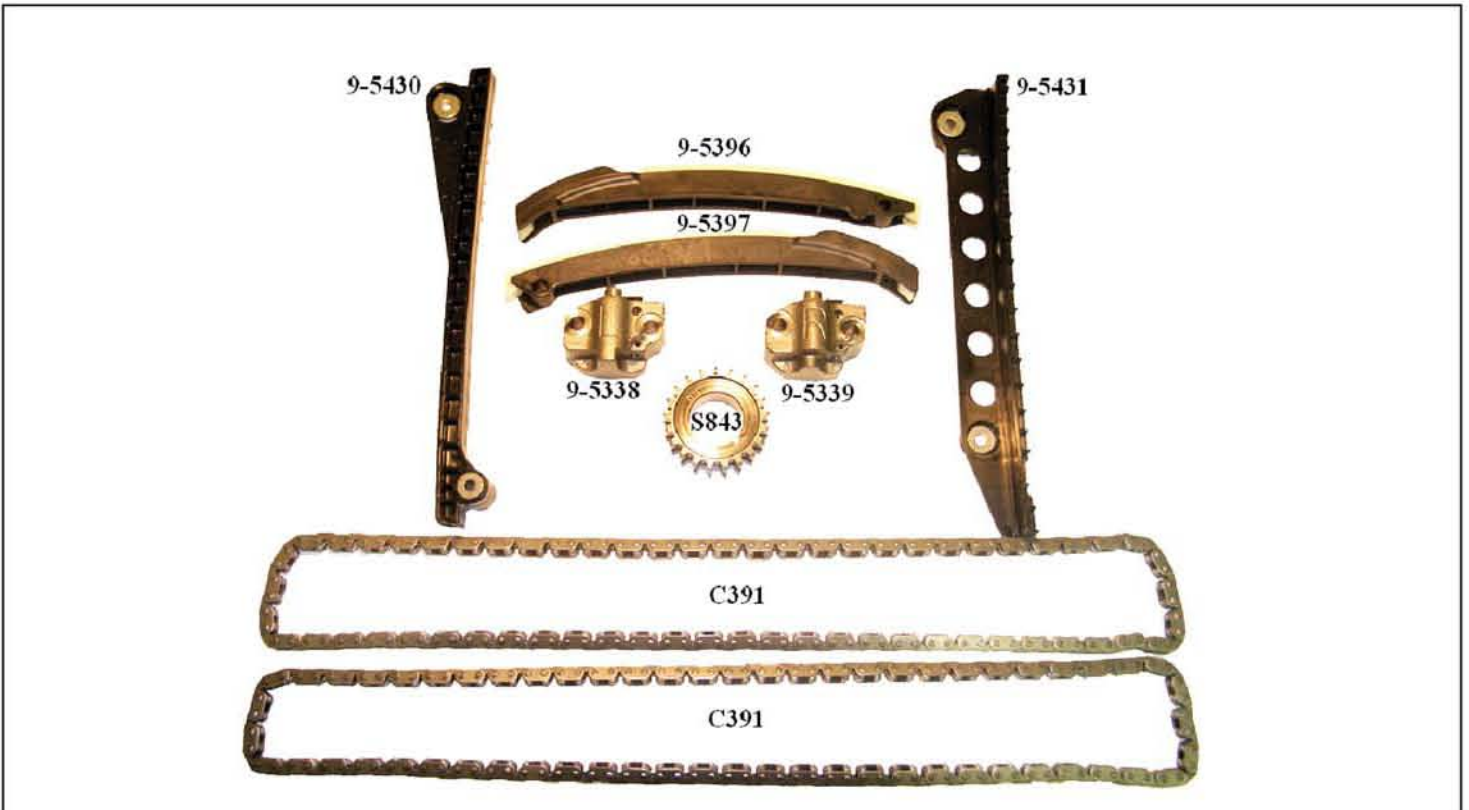

Ford

E Super Duty, E-150 E-250, E-350
Econoline, Excursion, Expedition,
F-150 F-250 PICKUP, 2002-2007.
Lincoln Mark LT Navigator 2005-07

Número de parte
9-0391SB

5.4L -L, M, Z, 3 (330) V8 (24 Válvulas)

Descripción		Número de parte	OE#
† Cigüeñal	21T	S869	XL3Z6306AA
† Cadena	122L	C391 1	5L3Z6268A
† Tensor, (IZQ.)		9-5432	XL1Z6L266AA
† Tensor, (DER.)		9-5433	1L3Z6L266AA
† Brazo tensor, (IZQ.)		9-5396	F85Z6M274AA
† Brazo tensor, (DER.)		9-5397	F85Z6K255AA
† Guía, (IZQ.)		9-5430	2L1Z6K297AA
† Guía, (DER.)		9 5431	4L3Z6M256AA
† Timing Kit		9-0391SB	

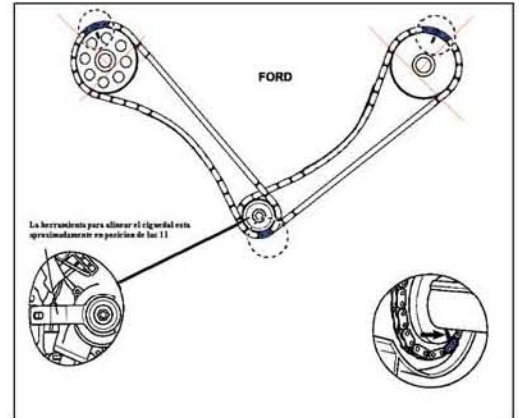

1 - 2 Requeridos

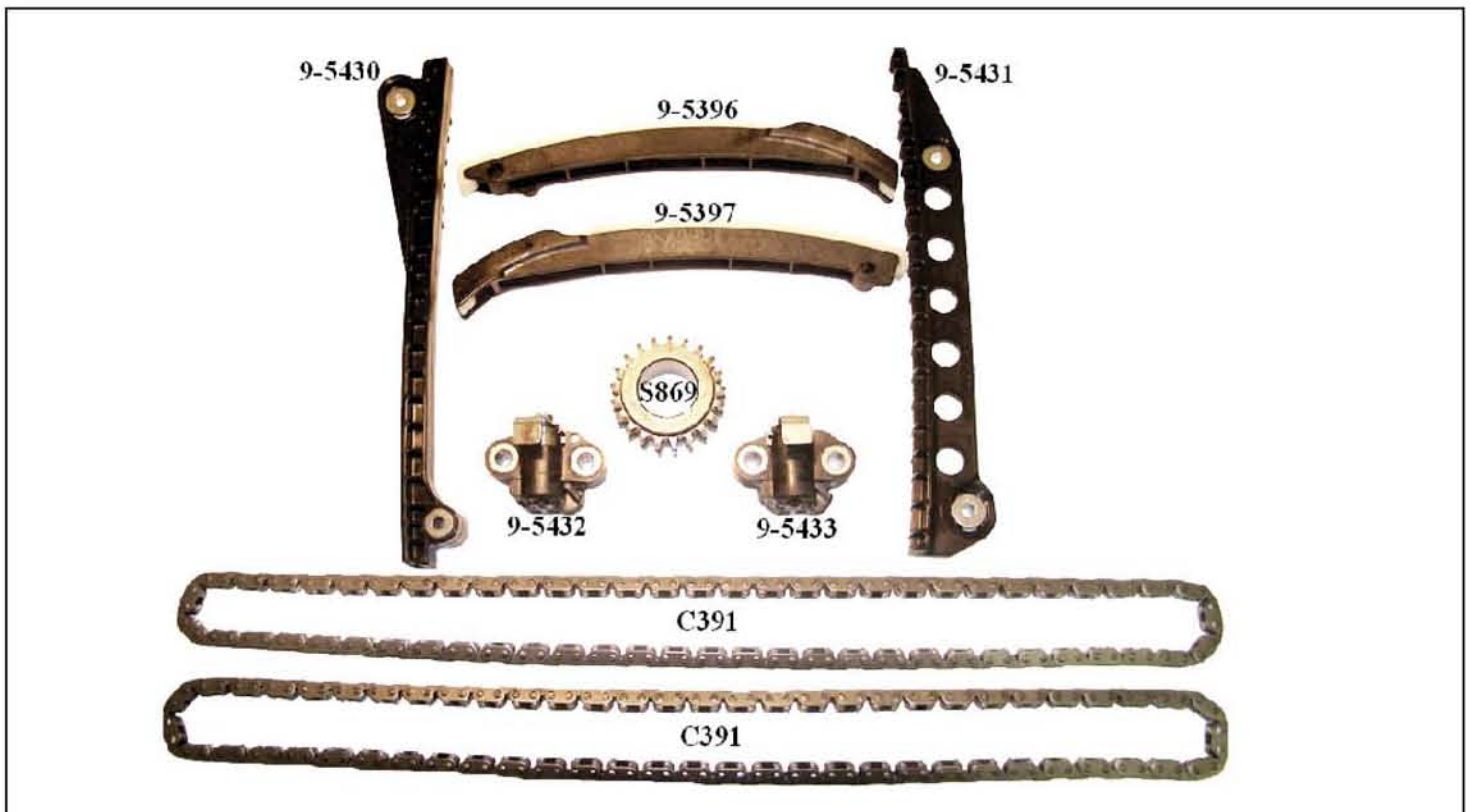



Ford

Ford E Super Duty E-350 Econoline,
F-250 F-350
F-450 F-550 Super Duty Pickup
1998-2001

Número de parte
9-0391SF

5.4L 6.8L -S(415) V10

Descripción	Número de parte	OE#
† Árbol de levas , (IZQ.)	42T	S764T
† Árbol de levas , (DER.)	42T	S766T
† Cigüeñal	21T	S843
† Cadena	116L	C391
† Tensor , (IZQ.)	9-5338	F6AZ6L266CA
† Tensor , (DER.)	9-5339	F6AZ6L266DA
† Brazo tensor , (DER.)	9-5396	F85Z6M274AA
† Brazo tensor , (IZQ.)	9-5397	F85Z6K255AA
† Guía , (DER.)	9-5430	F3AZ6K297A
† Guía , (IZQ.)	9-5431	F3AZ6K297B
Bal. Shf. Gear , (Driven)	27T	2771
Bal. Shf. Gear , (Driver)	54T	2772
†Timing Kit		9-0391SF

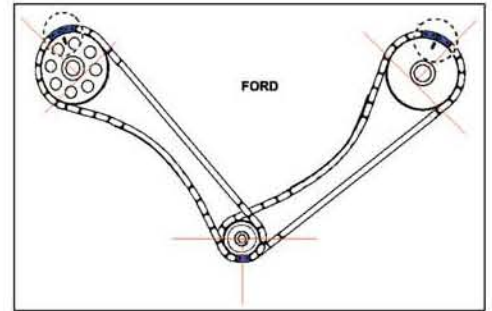

1 - 2 Requeridos

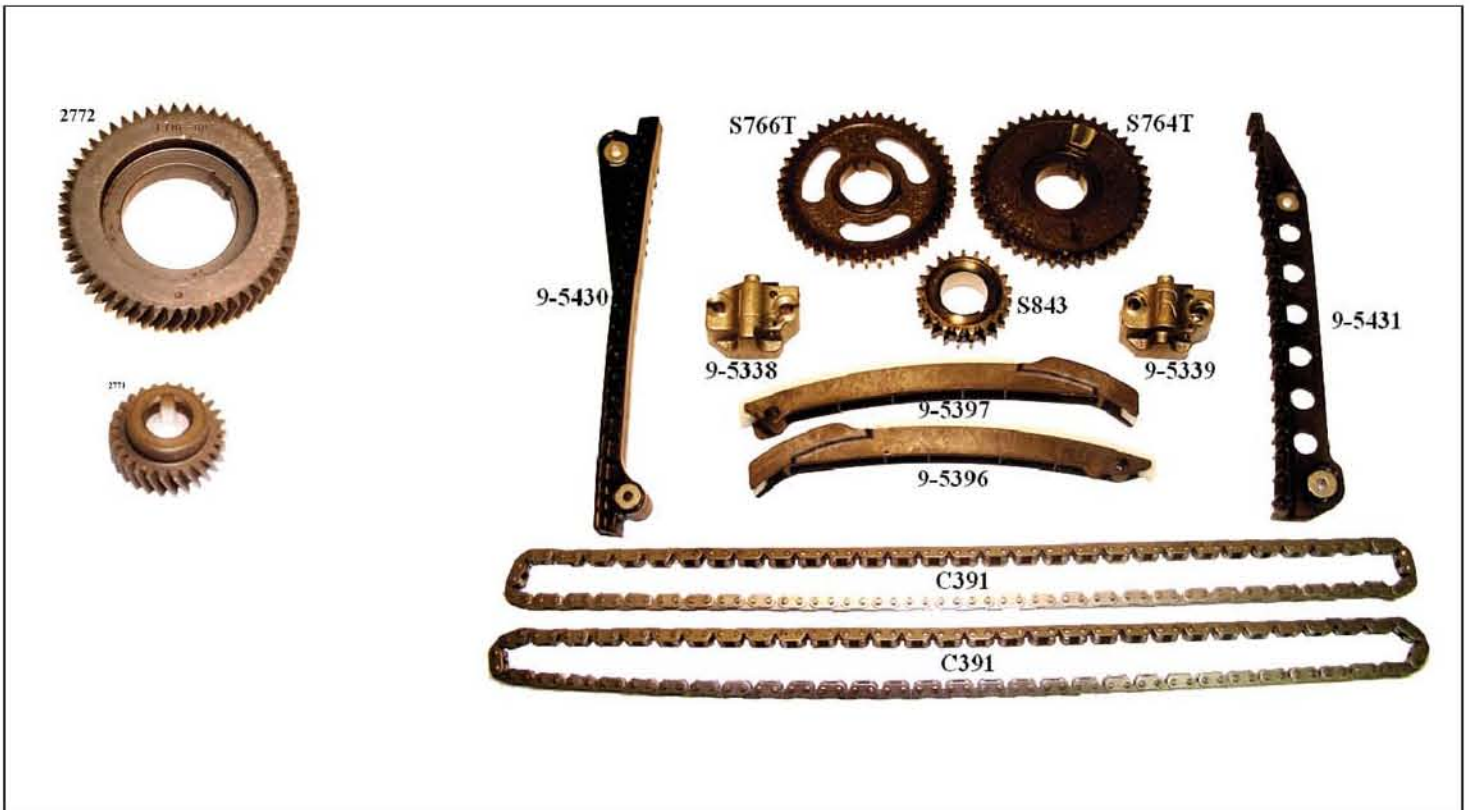

Ford

Ford E Super Duty E-350 Econoline,
F-250 F-350
F-450 F-550 Super Duty Pickup 2002
6.8L -S (415) V10

Número de parte
9-0391SG

Descripción	Número de parte		OE#
† Árbol de levas , (IZQ.)	42T	S764T	F8AZ6256BA
† Árbol de levas, (DER.)	42T	S766T	F8AZ6256AA
† Cigüeñal	21T	S869	XL3Z6306AA
† Cadena	116L	C391	5L3Z6268A
† Tensor , (IZQ.)		9-5338	F6AZ6L266CA
† Tensor, (DER.)		9-5339	F6AZ6L266DA
† Brazo tensor, (DER.)		9-5396	F85Z6M274AA
† Brazo tensor, (IZQ.)		9-5397	F85Z6K255AA
† Guía, (DER.)		9-5430	F3AZ6K297A
† Guía , (IZQ.)		9-5431	F3AZ6K297B
Bal. Shf. Gear , (Driven)	27T	2771	F7UZ6A304BC
Bal. Shf. Gear , (Driver)	54T	2772	F7UZ6A303BA
†Timing Kit		9-0391SG	

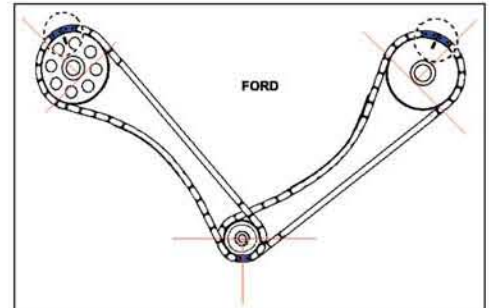

1 - 2 Requeridos





Ford

E150 E-350 E450, Excursion,
Expedition, F150-F350 F-450 F-550
2003-07

Número de parte
9-0391SH

5.4L-5 (330) SOHC V8, 6.8L-S (415) V10

Descripción	Número de parte		OE#
† Árbol de levas, (IZQ.)	42T	S764T	F8AZ6256BA
† Árbol de levas, (DER.)	42T	S766T	F8AZ6256AA
† Cigüeñal	21T	S869	XL3Z6306AA
† Cadena	116L	C391 1	5L3Z6268A
† Tensor, (IZQ.)	9-5432		XL1Z6L266AA
† Tensor, (DER.)	9-5433		1L3Z6L266AA
† Brazo tensor, (DER.)	9-5396		F85Z6M274AA
† Brazo tensor, (IZQ.)	9-5397		F85Z6K255AA
† Guía, (DER.)	9-5430		F3AZ6K297A
† Guía, (IZQ.)	9-5431		F3AZ6K297B
†Timing Kit	9-0391SH 2		

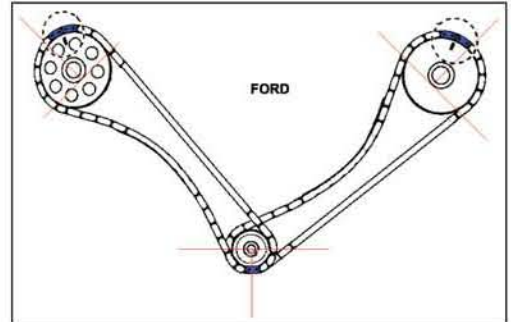

1 - 2 Requeridos
2 - For Non-Integrated Cam Sprockets



Ford

Taurus 2.5L 1986-91.
Tempo 2.3L 1984-94.
Sable 2.5L 1986

Número de parte
9-0505S
C-3052

2.3L -R, S, X (140) , 2.5L -N (153) OHV 4Cil. (HSC Engine)

Descripción	Número de parte	OE#	
†• Árbol de levas	36T	S618T	E43Z6256A
†• Cigüeñal	18T	S617	E43Z6306A
†• Cadena	46L	C505	E43Z6268A
• Tensor		9-5127	E43Z6K254A
† 3 Pc. Set		C-3052	
• Timing Kit		9-0505S	

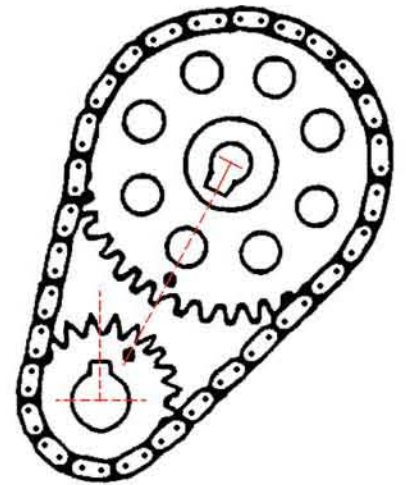



Honda

Civic del Sol, Civic L4 1.6L
1590cc (1992-1995)

Número de parte
BK-224

DESCRIPCIÓN		PART #	OE #
Correa	104T	B224	14400P28004
Tensor		9-5406	14520P2A305



Honda/Isuzu

Passport. 1994-97.
Acura SLX 1996-97.
Isuzu Rodeo, Trooper 1992-97

Número de parte
BK221

3.2 (3165CC) SOHC V6 (6VD1 Engine)

Descripción	Número de parte	OE#
Banda de distribución	223T	B221 8970163260
Tensor Auxiliar ò Rueda Loca	9-5473	8-94386488-3
Tensor de banda	9-5482	8943648161
Kit de Banda	BK221	



Honda/Isuzu	Passport. 1998-02. Isuzu Rodeo, Amigo, Axiom, Trooper 1998-04	Número de parte BK303
	3.2 (3165CC) DOHC V6 (6VD1 Engine)	

Descripción		Número de parte	OE#
Banda de distribución	191T	B303	8971363210
Polea loca Der.		9-5446	8971362560
Polea loca Izq.		9-5447	8971468770
Tensor de banda		9-5449	8971362570
Kit de Banda		BK303	



Hyundai	ACCENT 1300,1500CC	Número de parte BK-702
----------------	--------------------	----------------------------------

DESCRIPCIÓN	OEM #
BANDA DE DISTRIBUCION	24312-22613
TENSOR DE BANDA	24410-26000





Hyundai/Dodge

HYUNDAI GETZ,
DODGE BRISA

Número de parte
BK-703

1,100CC 4L (04-09)

DESCRIPCIÓN	OEM #
BANDA DE DISTRIBUCION	24312-26001
TENSOR DE BANDA GRANDE	24410-26000
TENSOR AUXILIAR, RUEDA LOCA	24810-26020



Hyundai

H1

Número de parte
BK-706

DESCRIPCIÓN	OEM #
BANDA DE DISTRIBUCION GRANDE	24315-42200
BANDA DE DISTRIBUCION PEQUEÑO	23356-42500
TENSOR DE BANDA GRANDE	24317-42020
TENSOR DE BANDA PEQUEÑO	23357-42030



Hyundai

SANTAFE

Número de parte
BK-704

DESCRIPCIÓN	OEM #
BANDA DE DISTRIBUCION	24312-27000
TENSOR DE BANDA GRANDE	24410-27000
TENSOR AUXILIAR, RUEDA LOCA	24810-27000



Hyundai

TUCSON 2.0L DOHC

Número de parte
BK-705

DESCRIPCIÓN	OEM #
BANDA DE DISTRIBUCION	24312-23202
TENSOR DE BANDA GRANDE	24410-23050
TENSOR AUXILIAR, RUEDA LOCA	24810-23050





Jeep

CHEROKEE
V6 CIL 4.0L
(94-06)

Número de parte
C-3041

DESCRIPCIÓN		PART #	OE #
ARBOL DE LEVAS	48T	S808T	53020445
CIGUEÑAL	24T	S809	53020443
CADENA	64L	C385	53020444



Jeep

GRAND CHEROKEE V8 5.2L
(90-03)

Número de parte
C-3072

DESCRIPCIÓN		PART #	OE #
ARBOL DE LEVAS	46T	S712T	44486756
CIGUEÑAL	23T	S721	4448674
CADENA	68L	C380	56005773





KIA

Picanto

**Número de parte
BK-709**

DESCRIPCIÓN	OEM #
BANDA DE DISTRIBUCION	24312-02701
TENSOR DE BANDA	24410-02550



KIA

RIO

**Número de parte
BK-708**

1,100CC 4L (04-09)

DESCRIPCIÓN	OEM #
BANDA DE DISTRIBUCION	0K30E-12-205
TENSOR DE BANDA GRANDE	24410-2X701
TENSOR AUXILIAR, RUEDA LOCA	24810-2X700



Lincoln

Continental, Mark VIII 1993-95

Número de parte
9-0387SB

4.6L -V(281) DOHC V8

Descripción	Número de parte	OE#
† Árbol de levas , (IZQ.)	42T S764T	F3AZ6256A
† Árbol de levas , (DER.)	42T S766T	F7LZ6256AA
† Árbol de levas , (Secundario)	20T S790 1	F3LY6256A
† Cigüeñal	21T S843	F3AZ6306A
† Cadena , (Secundario)	44L C189 2	F3LY6268B
† Cadena , (Primario)	116L C387 2	5W7Z6268AA
† Tensor, (Primario IZQ.)	9-5371	F5AZ6L266AA
† Tensor, (Primario DER.)	9-5372	F5AZ6L266BA
† Tensor, (Secundario DER.)	9-5394	F7LZ6K254AA
† Tensor, (Secundario IZQ.)	9-5395	F7LZ6K254BA
† Brazo tensor, (IZQ.)	9-5462	1R3Z6L253AA
† Brazo tensor, (DER.)	9-5463	1R3Z6L253BA
† Guía , (IZQ.)	9-5459	F3LY6K297A
† Guía, (DER.)	9-5461	1R3Z6M256AA

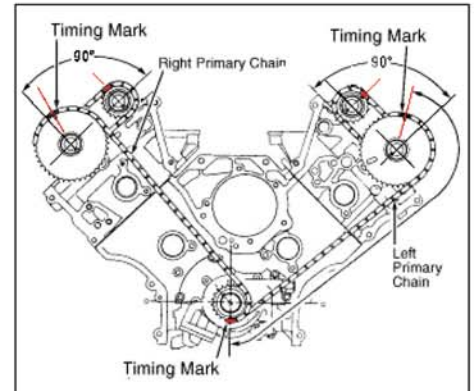

†Timing Kit

9-0387SB

- 1 - Requiere 4
- 2 - 2 Requeridos

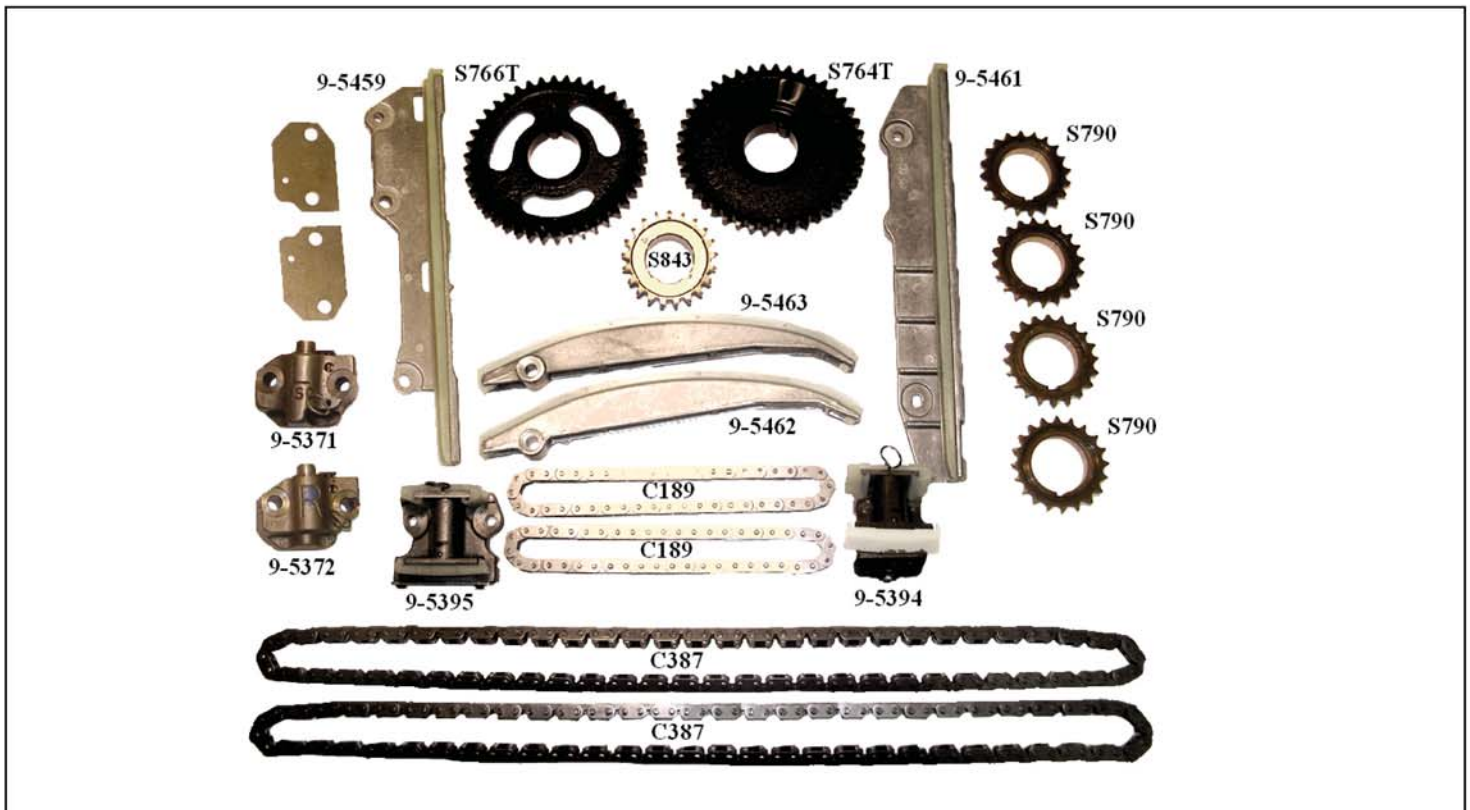



Lincoln

Continental, Mark VIII 1996-97

Número de parte
9-0387SC

4.6L -V(281) DOHC V8

Descripción	Número de parte		OE#
† Árbol de levas , (IZQ.)	42T	S764T	F3AZ6256A
† Árbol de levas , (DER.)	42T	S766T	F7LZ6256AA
† Árbol de levas , (Secundario)	20T	S790 1	F3LY6256A
† Cigüeñal	21T	S843	F3AZ6306A
† Cadena , (Secundario)	44L	C189 2	F3LY6268B
† Cadena , (Primario)	116L	C387 2	5W7Z6268AA
† Tensor, (Primario IZQ.)	9-5338		F6AZ6L266CA
† Tensor, (Primario DER.)	9-5339		F6AZ6L266DA
† Tensor, (Secundario DER.)	9-5394		F7LZ6K254AA
† Tensor, (Secundario IZQ.)	9-5395		F7LZ6K254BA
† Brazo tensor, (IZQ.)	9-5462		1R3Z6L253AA
† Brazo tensor, (DER.)	9-5463		1R3Z6L253BA
† Guía , (IZQ.)	9-5459		F3LY6K297A
† Guía , (DER.)	9-5461		1R3Z6M256AA
† Timing Kit	9-0387SC		

1 - Requiere 4

2 - 2 Requeridos

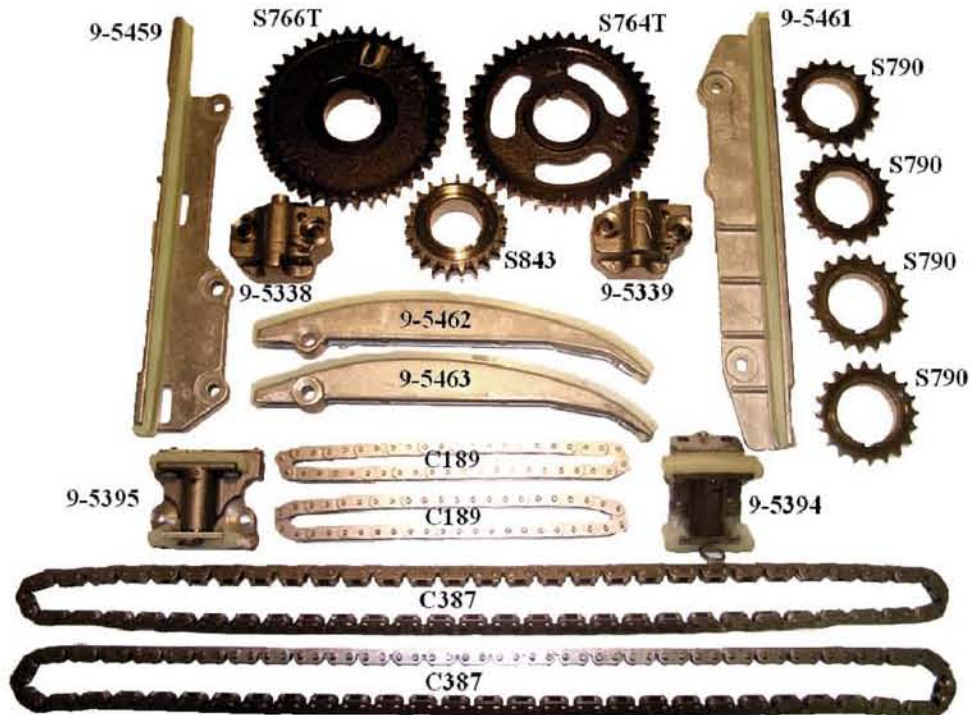
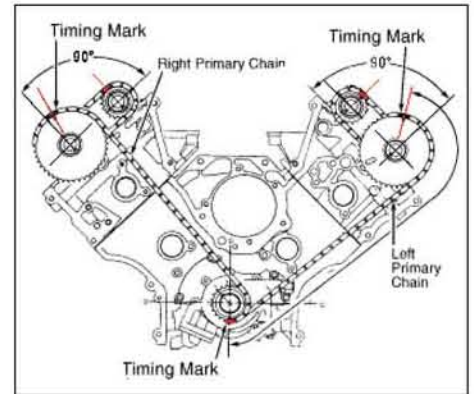

Lincoln

Continental, Mark VIII 1998-00

Número de parte
9-0387SD

4.6L -V(281) DOHC V8

Descripción	Número de parte	OE#
† Árbol de levas , (IZQ.)	42T S764T	F3AZ6256A
† Árbol de levas , (DER.)	42T S766T	F7LZ6256AA
† Árbol de levas , (Secundario)	20T S790A ¹	F8ZZ6256AA
† Cigüeñal	21T S843	F3AZ6306A
† Cadena , (Secundario)	44L C189 ²	F3LY6268B
† Cadena , (Primario)	116L C387 ²	5W7Z6268AA
† Tensor, (Primario IZQ.)	9-5338	F6AZ6L266CA
† Tensor, (Primario DER.)	9-5339	F6AZ6L266DA
† Tensor, (Secundario DER.)	9-5394	F7LZ6K254AA
† Tensor, (Secundario IZQ.)	9-5395	F7LZ6K254BA
† Brazo tensor, (IZQ.)	9-5462	1R3Z6L253AA
† Brazo tensor, (DER.)	9-5463	1R3Z6L253BA
† Guía , (IZQ.)	9-5459	F3LY6K297A
† Guía, (DER.)	9-5461	1R3Z6M256AA
† Timing Kit	9-0387SD	

1 - Requiere 4
2 - 2 Requeridos

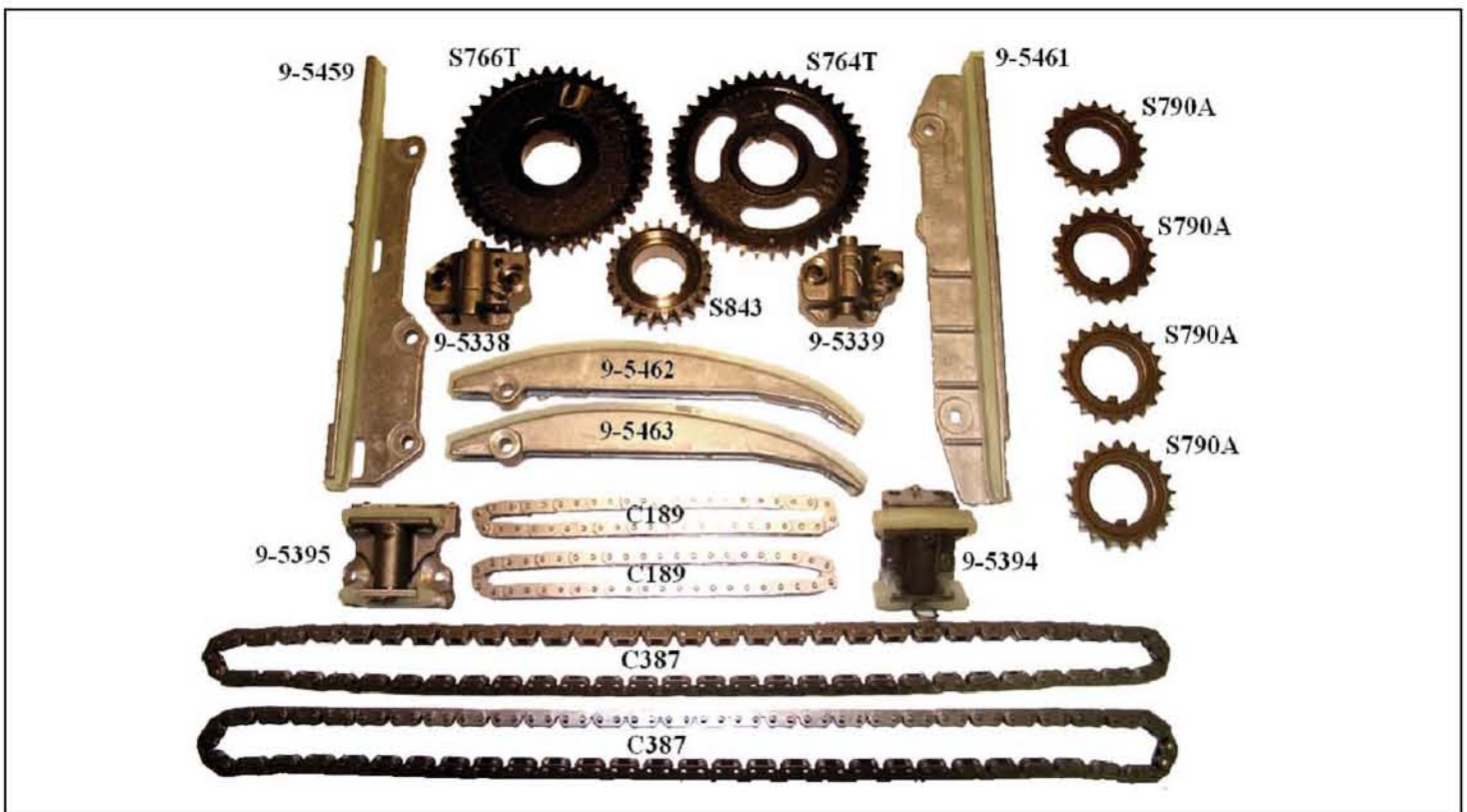
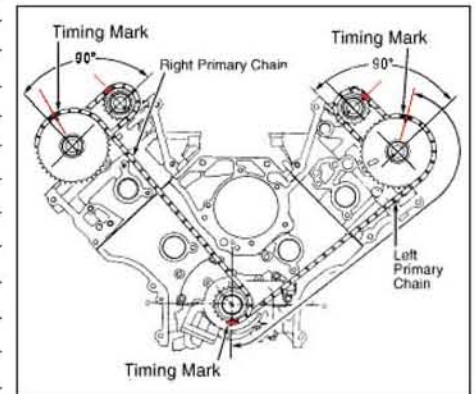



Lincoln

CONTINENTAL (2001-2002)

Número de parte **9-0387SE**

DESCRIPCIÓN		PART #	OE #
Abol de Levas (Izquierda)	42T	S764T	F3AZ6256A
Abol de Levas (Derecha)	42T	S766T	F7LZ6256AA
Abol de Levas (Secundario)	20T	S790A	F8ZZ6256AA
Cigüeñal	21T	S869	XL3Z6306AA
Cadena (Secundaria)	44L	C189	F3LY6268B
Cadena (Primario)	116	C387	5W7Z6268AA
Tensor (Primario Izquierdo)		9-5338	F6AZ6L266CA
Tensor (Primario Derecho)		9-5339	F6AZ6L266DA
Tensor (Secundario Derecho)		9-5394	F7LZ6K254AA
Tensor (Secundario Izquierdo)		9-5395	F7LZ6K254BA
Brazo Tensor (Izquierdo)		9-5462	1R3Z6L253AA
Brazo Tensor (Derecho)		9-5463	1R3Z6L253BA
Guía (Izquierda)		9-5459	F3LY6K297A
Guía (Derecha)		9-5461	1R3Z6M256AA

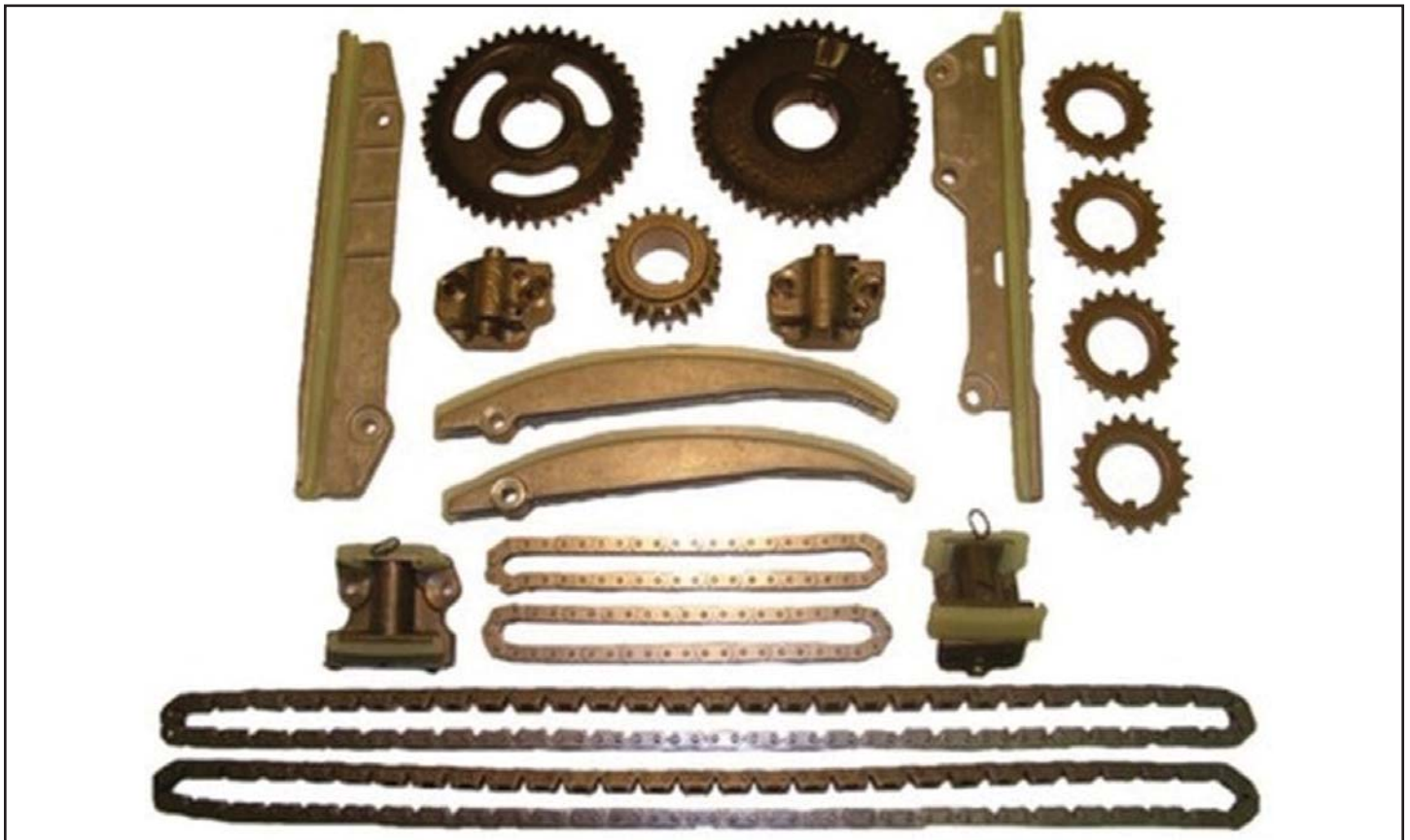

Nissan

200SX, NX, Sentra L4 1.6L
(1991-1999)

Número de parte
9-4174S

DESCRIPCIÓN		PART #	OE #
Arbol de Levas	25T	S720	1302453Y01
Cigüeñal	18T	S731	1302153Y01
Cadena (Inferior)	80L	9-4174	1302855Y00
Cadena (Superior)	54L	9-4175	1302855Y10
Tensor (Superior)		9-5229	1307053Y13
Tensor (Inferior)		9-5230	1307053Y00
Guía (Inferior Derecha)		9-5234	1309153Y00
Guía (Inferior Izquierda)		9-5347	130850M300
Rueda Loca		S737	130770M300
Pestillo		08120-8161	

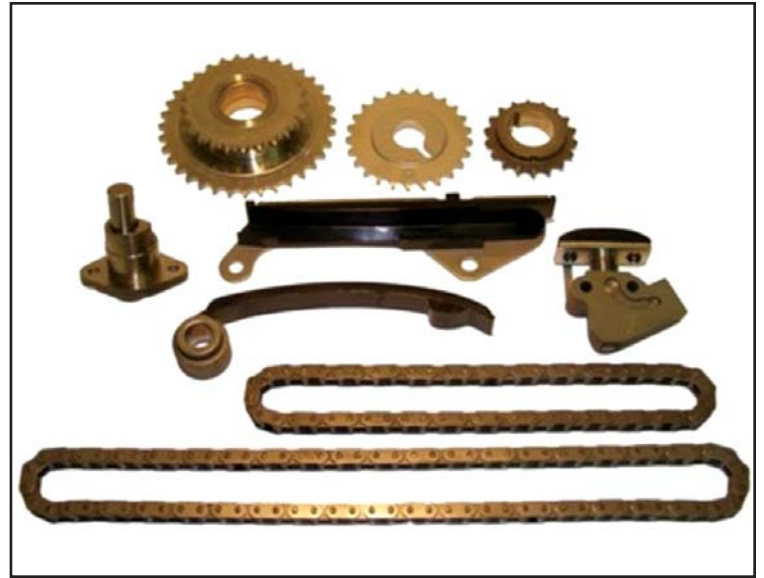

Nissan/Infinity

D21, Frontier, Maxima,
Pathfinder, Pickup, Quest,
Xterra; QX4 V6 3.0L, V6 3.3L
(1994-2004)

Número de parte
BK-249

DESCRIPCIÓN		PART #	OE #
Correa	133T	B249	130280B700
Tensor		9-5124	13070V5001





Nissan/Renault

Platina, Clio II, Kangoo, Laguna,
Scenic, 2002-08

Número de parte
BK400

1.6L, 16V DOHC K4M Eng.

Descripción	Número de parte	OE#
Banda de distribución	132T	B400
Tensor de banda	9-9402	16806-00QA7
Tensor auxiliar o rueda loca	9-9403	13070-00QAB
Tornillo	9-9412	13070-00QAA
Kit de banda	BK400	



Nissan

PL410, L320, PL411, L520, Pick UP
1963-65.
L521 Pick Up 1966-69

Número de parte
9-4052S

J12 (1200cc) . J13 (1300cc) 4 Cil.

Descripción	Número de parte	OE#
† Árbol de levas	40T	S470
† Cigüeñal	20T	S471
† Cadena	52L	9-4052
† Tensor	9-5006	1302810601
† Timing Kit	9-4052S	

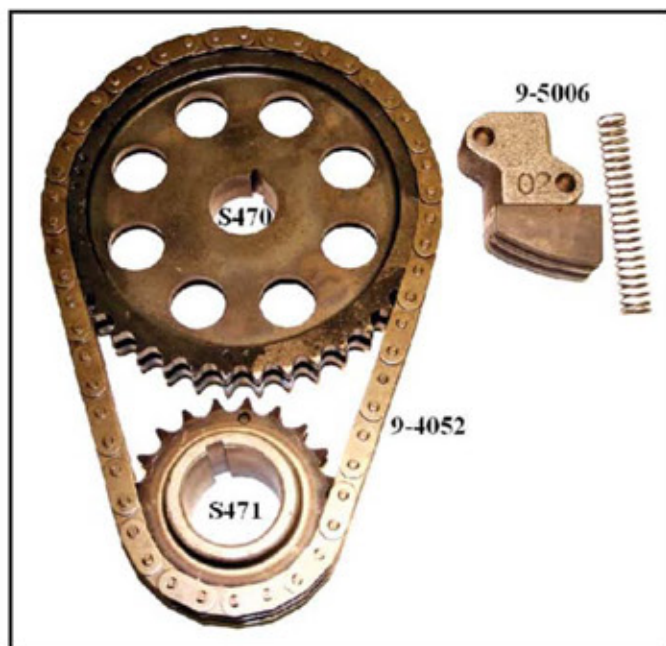

Nissan	Pulsar, Sentra, NX, Tsuru 1989-90	Número de parte 9-4164S
GA16, I (1597cc) SOHC 4 Cil.		

Descripción	Número de parte		OE#
† Árbol de levas	38T	S686	1302477A00
† Cigüeñal	19T	S693	1302177A00
† Cadena	92L	9-4164	1302877A01
† Tensor		9-5179	1305077A12
† Guía , (Lado de Flojo)		9-5181	1309177A01
† Guía (Lado de tensión)		9-5346 1	1308577A04
† Timing Kit		9-4164S	

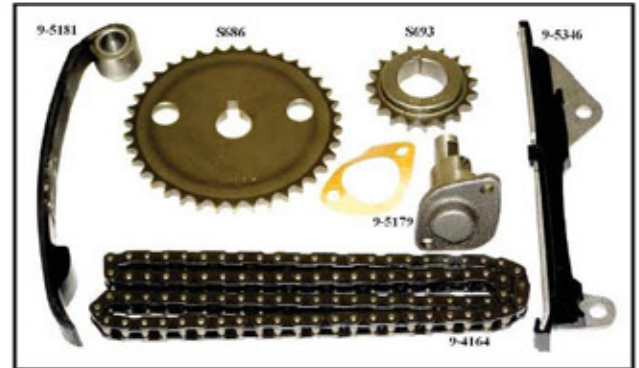

1 - Use Tornillos 08120-8161E con esta Guía

Nissan	Tsuru, Sentra, Pulsar, 310 1981-91	Número de parte BK077
E15, E15T (1488cc) E16, S, I (1597cc) 4 Cil.		

Descripción	Número de parte		OE#
Árbol de levas	40T	S660 1	1302401M01
Cigüeñal	20T	S557	1302101M00
† Banda	106T	B077	1302811M00
† Tensor de banda		9-5075	1307001M00
† Kit de banda		BK077	

1-SOLO PARA E16





Nissan

Pulsar, Sentra, Tsuru III, NX Tsubame
1990-94

Número de parte
9-4174SX

1.6L GA16DE (1597cc) DOHC

Descripción	Número de parte	OE#
Engrane de árbol (izq.)	25T S720 ¹	1302453Y01
Engrane de cigüeñal	18T S731	1302153Y01
Cadena (inferior)	80L 9-4174	1302855Y00
Cadena (superior)	54L 9-4175	1302855Y10
Guía (inferior derecha)	9-5234	1309153Y00
Guía (inferior izquierda)	9-5347 ²	130850M300
Engrane Aux. (36T & 25T)	S737	130770M300
Tensor (Superior)	9-5229	13070AN201
Tensor (Inferior)	9-5230	1307053Y00
Kit de Distribución	9-4174SX	

1 - 2 Requeridos

2- Use tornillos 08120-8161E con esta Guía

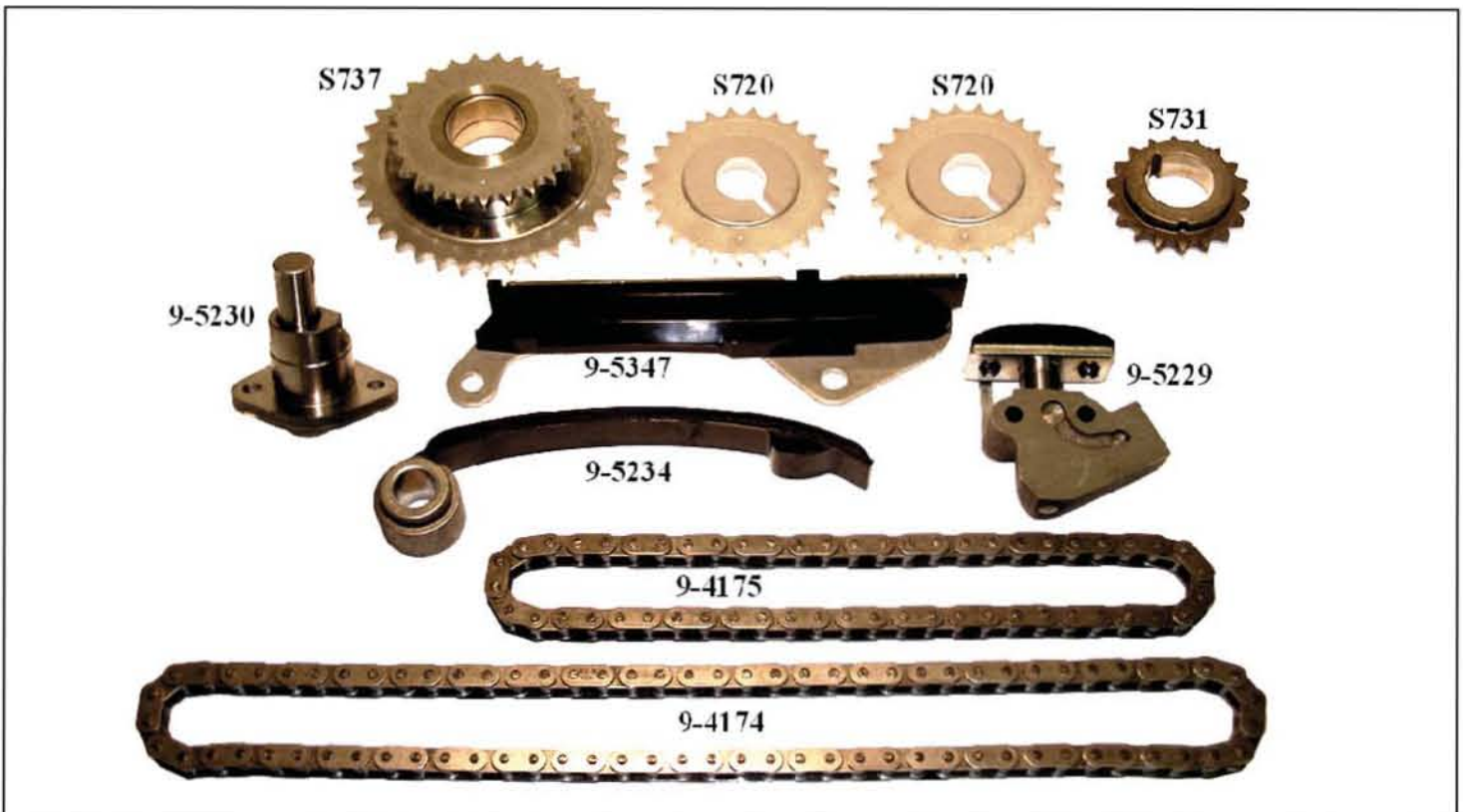
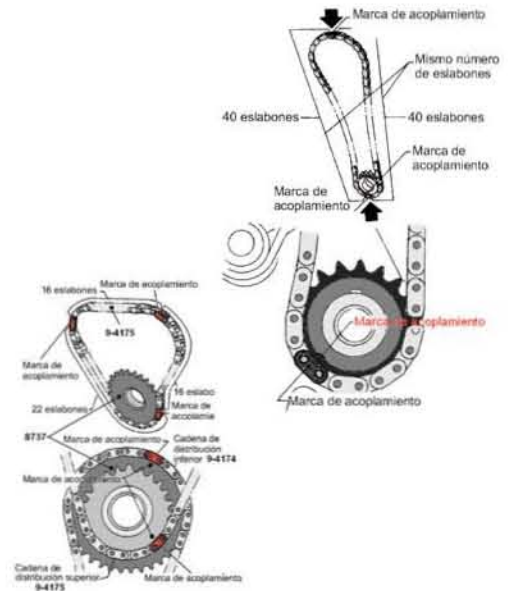

Nissan

Sentra, NX
2000-06

Número de parte
9-0724S

QG18DE (1809CC) 4 Cil.

Descripción	Número de parte	OE#	
† Árbol de levas	42T	S936T	130245M000
† Cigüeñal	21T	S935	130215M000
† Cadena	154L	C724F	130288U300
† Tensor		9-5541	13070AU000
† Brazo tensor		9-5540	130915M000
† Guía, (Inferior)		9-5538	130855M010
† Guía, (Superior)		9-5539	130855M000
† Timing Kit		9-0724S	

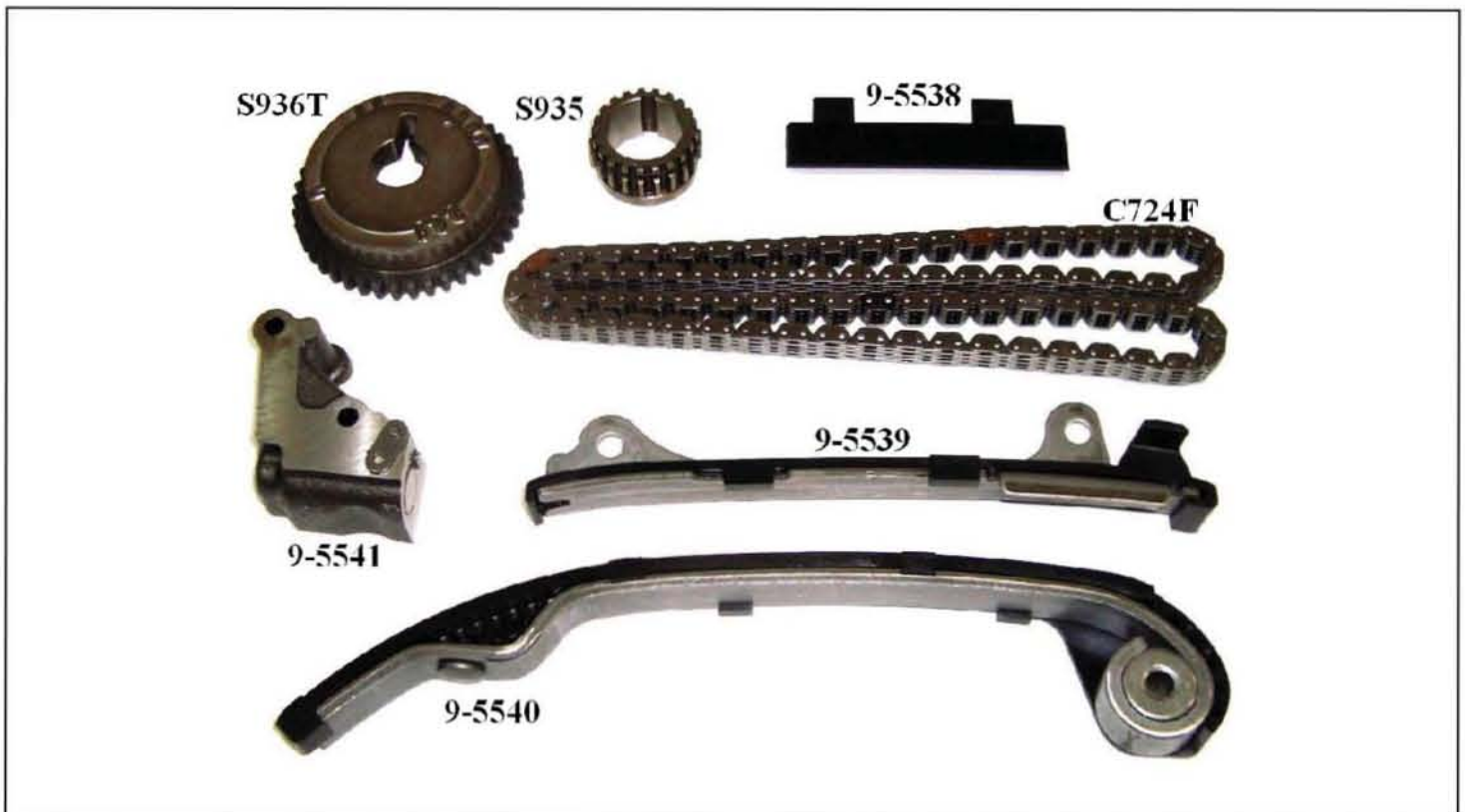
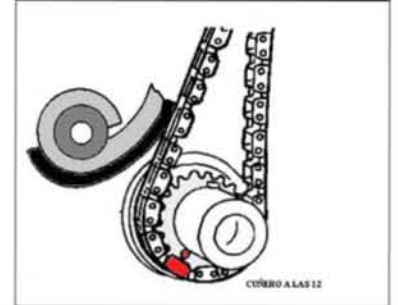
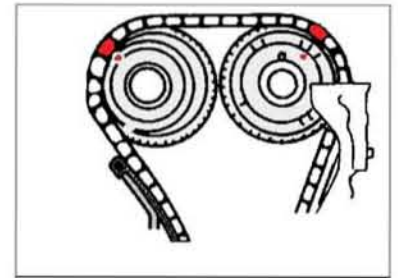



Nissan/Datsun

510, 200SX, 610, S620 Pick Up, 710,
720 Pick Up 1974-83

Número de parte

9-4136S

L20B (1952cc) 4 Cil.

Descripción		Número de parte	OE#
† Árbol de levas	40T	S462	13024U8000
† Cigüeñal	20T	S463	13021U8010
† Cadena	114L	9-4136	13028U6000
† Tensor		9-5007	1307021002
† Damper , (Inferior)		9-5028	13091A3500
† Damper , (Superior)		9-5123	13085W3401
† Timing Kit		9-4136S	

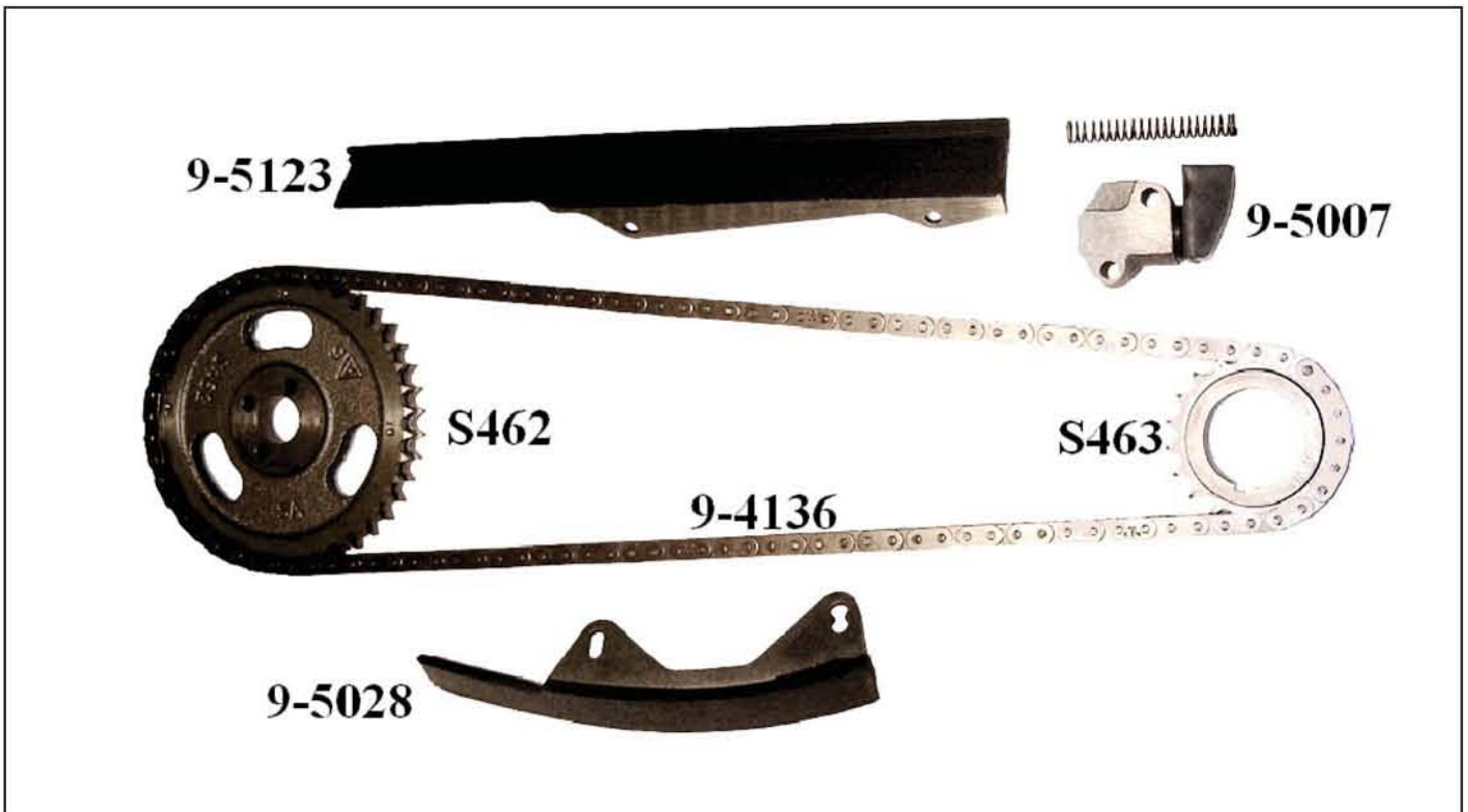

Nissan

Z20E, S 200SX, 510, 720 1979-83.
Z22, E 200SX, 510, 720 1981-83.

Número de parte
9-4131S

Z20E, S (1952CC) . Z22, E (2187CC) 4 Cyl.

Descripción		Número de parte	OE#
† Árbol de levas	40T	S462	13024U8000
† Cigüeñal	20T	S463	13021U8010
† Cadena	102L	9-4131	13028N8400
† Tensor		9-5007	1307021002
† Guía, (IZQ.)		9-5054	13085N8400
† Guía, (DER.)		9-5055	13091W0400
† Timing Kit		9-4131S	

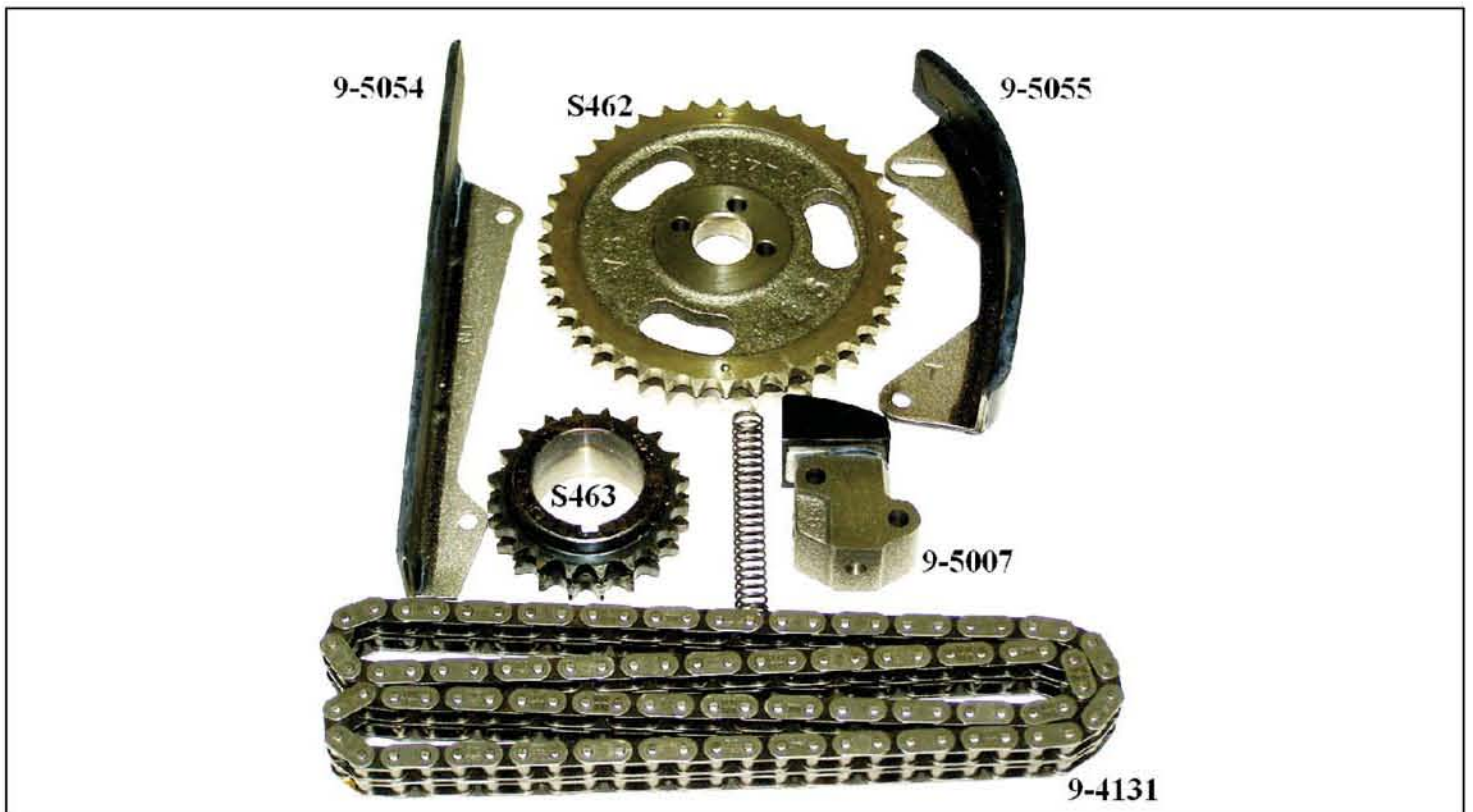



Nissan

Altima, Frontier, Xterra, 1998-2004,
(Urvan 1999-2003)

Número de parte
9-4180SA

KA24DE 2.4L (2389cc) 4 Cil.

Descripción	Número de parte	OE#
Árbol de levas	19T S920T ¹	130249E000
Cigüeñal	18T S699	1302140F01
Cadena, (Inferior)	92L 9-4210	13028ZD00A
Cadena, (Superior)	48L 9-4211	130289E010
Tensor, (Inferior)	9-5235	130704E102
Tensor, (Superior)	9-5236	1307053F16
Guía, (DER.)	9-5239	130919E000
Guía, (IZQ.)	9-5240	130851E401
Sprocket intermedio	36T & 19T S909	130779E000

Timing Kit

1 - 2 Requeridos

9-4180SA

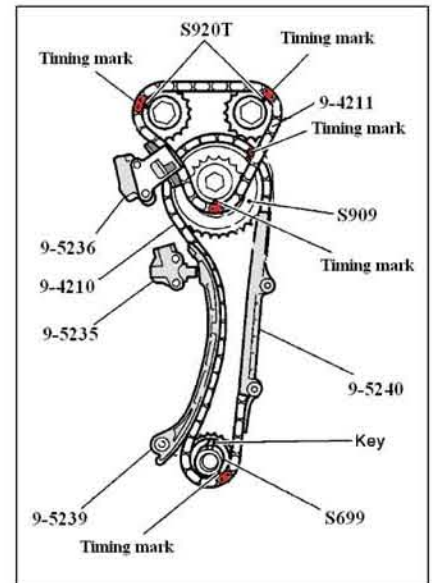

<h1>Nissan</h1>	Pick Up 720 1983-86, D21 1986-88, Pathfinder 1987-88, Nissan Van 1987-88.	Número de parte 9-4147S
	2.4L Z24 (2389cc) 4 Cyl.	

Descripción	Número de parte	OE#
† Árbol de levas	40T S462	13024U8000
† Cigüeñal	20T S463	13021U8010
† Cadena	106L 9-4147	1302810W00
† Tensor	9-5007	1307021002
† Guía, (IZQ.)	9-5121	1308510W10
† Guía, (DER.)	9-5122	1309110W00
† Timing Kit	9-4147S	





Nissan

Pathfinder, Van, Truck
1989-91

Número de parte
9-4159S

Z24, I (2389cc) 4 Cil.

Descripción		Número de parte	OE#
† Árbol de levas	40T	S698	1302403G00
† Cigüeñal	20T	S701	1302103G00
† Cadena	106L	9-4159	1302803G00
† Tensor		9-5007	1307021002
† Guía, (IZQ.)		9-5121	1308510W10
† Guía, (DER.)		9-5122	1309110W00
† Timing Kit		9-4159S	

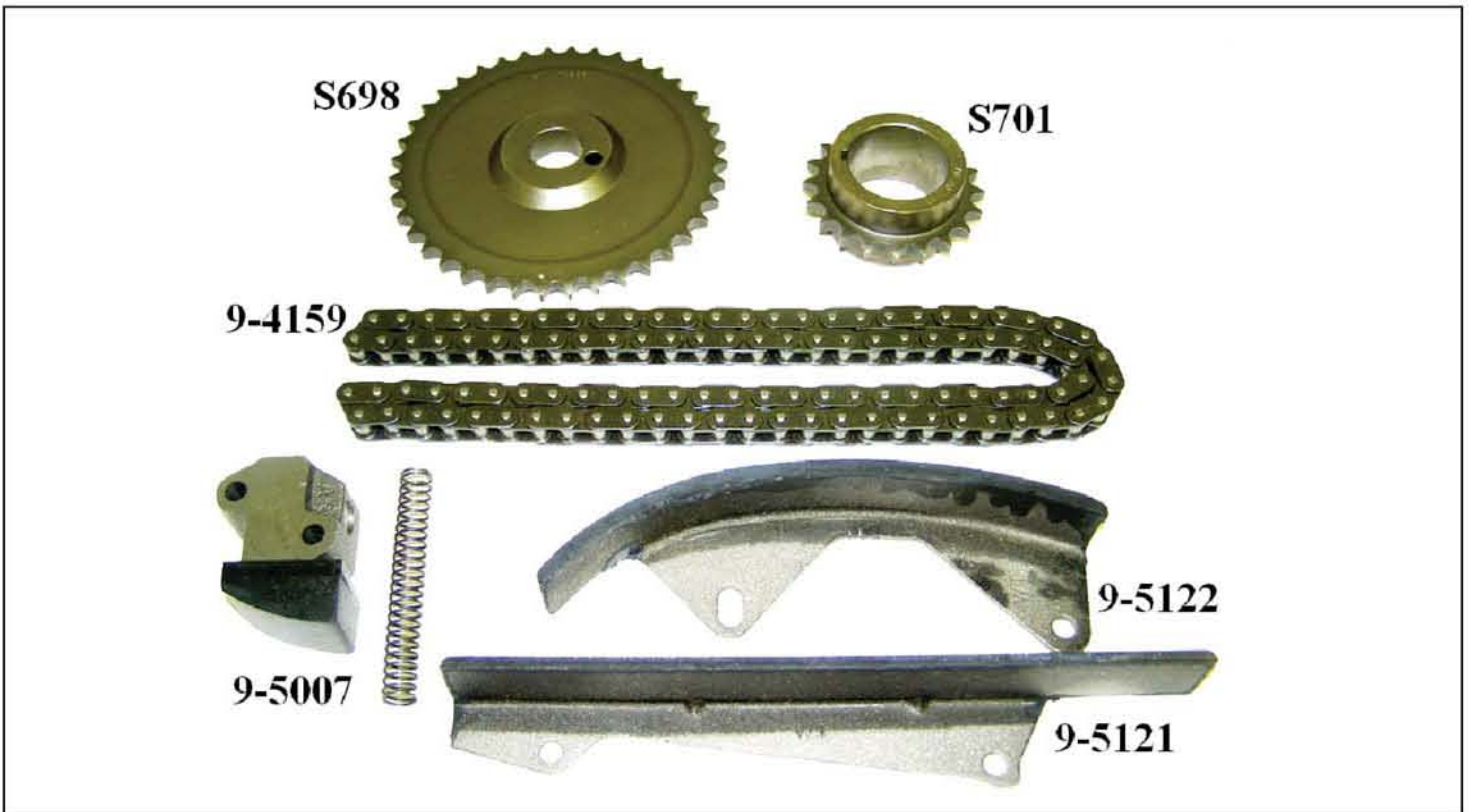

Nissan

Altima, Sentra, X-trail, Spec-V, Urvan
2002-06

Número de parte

9-4212S

QR25DE 2.5L (2500CC)

Descripción		Número de parte	OE#
Árbol de levas	44T	S922T	13024EA000
Cigüeñal	38T	S907	13021EA000
Cadena	164L	9-9412	13028JA00A
Tensor		9-5500	130708J012
Tensor, (Bal. Shaft)	70L	9-5501	130708J000
Guía, (Lado flojo)		9-5502	13085EA000
Guía, (TOP)		9-5503	130858J010
Guía, (Lado tensor)		9-5507	13091JA00A
Cadena Bal. Shf.		9-4213	150418J015
Timing Kit		9-4212S	

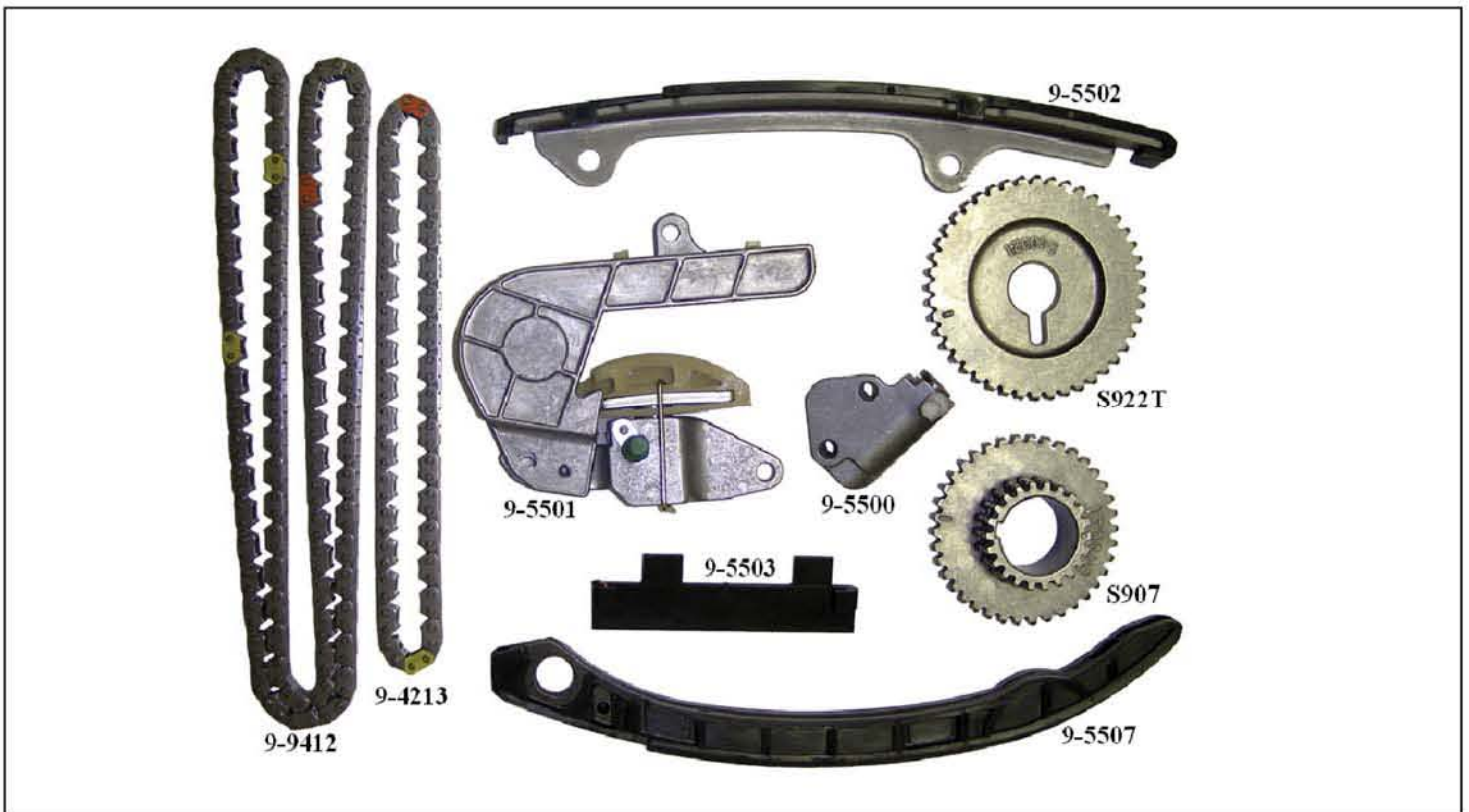
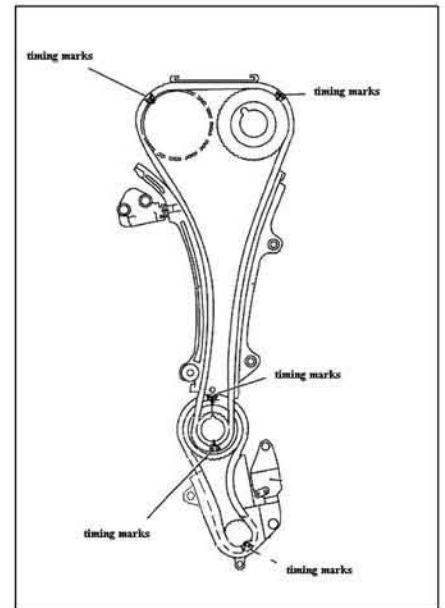



Nissan

Maxima, 1996-01
INFINITI I30 1996-01

Número de parte
9-4207S

VQ30DE (2988CC) V6

Descripción	Número de parte	OE#
† Árbol de levas , (Externo)	42T S884 1	1302431U00
† Árbol de levas , (Exhaust)	24T S886 1	1302431U21
† Árbol de levas , (Intake)	24T S888 1	1302431U11
† Cigüeñal	21T S885	1302131U00
† Cadena , (Inferior)	138L 9-4207	1302831U00
† Cadena , (Superior)	44L 9-4208 1	1302831U12
† Tensor, (Inferior DER.)	9-5436	1307031U03
† Tensor, (Superior IZQ.)	9-5441	13070AL515
† Tensor, (Superior DER.)	9-5442	13070AL510
† Brazo tensor, (2001-1/96)	9-5437	130912Y001
† Guía , (Superior)	9-5438	1308531U02
† Guía, (Inferior IZQ.)	9-5439	1308531U16
† Guía, (Superior IZQ.)	9-5440	1308531U11
† Timing Kit , (2001-1/96)	9-4207S	



Peugeot	206 2001-07	Número de parte BK404
1.6L (1587cc) 4Cil 16V TU5JP4 Eng.		

Descripción		Número de parte	OE#
Banda de distribución	134T	B404	0816.H6
Tensor de banda		9-9416	0829.C7
Tensor Auxiliar ò Rueda Loca		9-9417	0830.61
Kit de Banda		BK404	

SOLO TENSOR METALICO



Pontiac/Chevrolet	Matiz 2003-2005 Spark	Número de parte BK-701
1.0L (995cc/1000cc) SOHC 4Cil		

DESCRIPCIÓN		PART #	OE #
BANDA DE DISTRIBUCIÓN	109T	B405	96610029
TENSOR DE BANDA		9-9415	94580139
KIT DE BANDA		BK405	

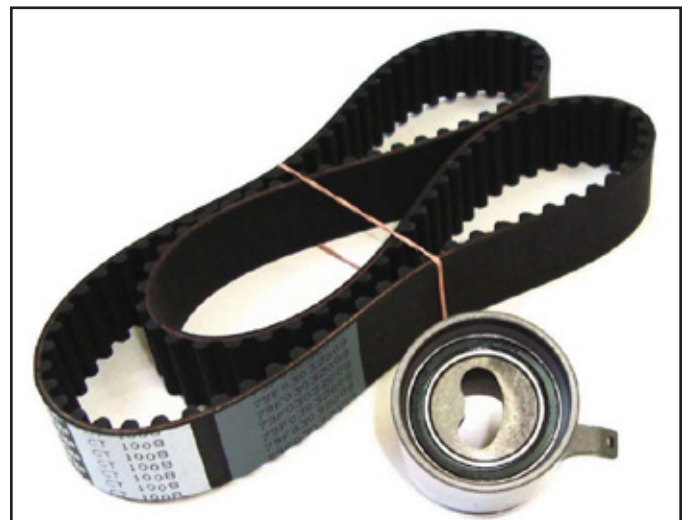



Renault

Megane I 2001-04,
Scenic 2001-03,
Clio sport 2003-06

Número de parte
BK407

2.0L (1998cc) DOHC 4 Cil.

Descripción	Número de parte	OE#
Banda de distribución	128T	B407
Tensor de banda		9-9409
Tensor auxiliar o rueda loca		9-9410
Tensor auxiliar o rueda loca		9-9419
Kit de banda	BK407	



Renault

Megane II, Scenic 2004-08

Número de parte
BK403

2.0L (1998cc) DOHC F4R Eng.

Descripción	Número de parte	OE#
Banda de distribución	126	B403
Tensor de banda		9-9409
Tensor auxiliar o rueda loca		9-9410
Tornillo		9-9411
Kit de banda	BK403	



Saturn

SC2, SL2, SW2 1991-98

Número de parte
9-4189S

1.9L -7 (1901CC) DOHC 4 Cyl.

Descripción	Número de parte	OE#	
†• Árbol de levas	38T	S786T 1	21000032
†• Cigüeñal	19T	S773	21000280
†• Cadena	126L	9-4189	21000336
• Tensor		9-5327	21006504
• Guía, (DER.)		9-5328	21006035
• Guía, (IZQ.)		9-5329	21000339
• Guía, (Superior)		9-5330	21006435
† 3 Pc. Set		C-3209	
• Timing Kit		9-4189S	

1 - 2 Requeridos

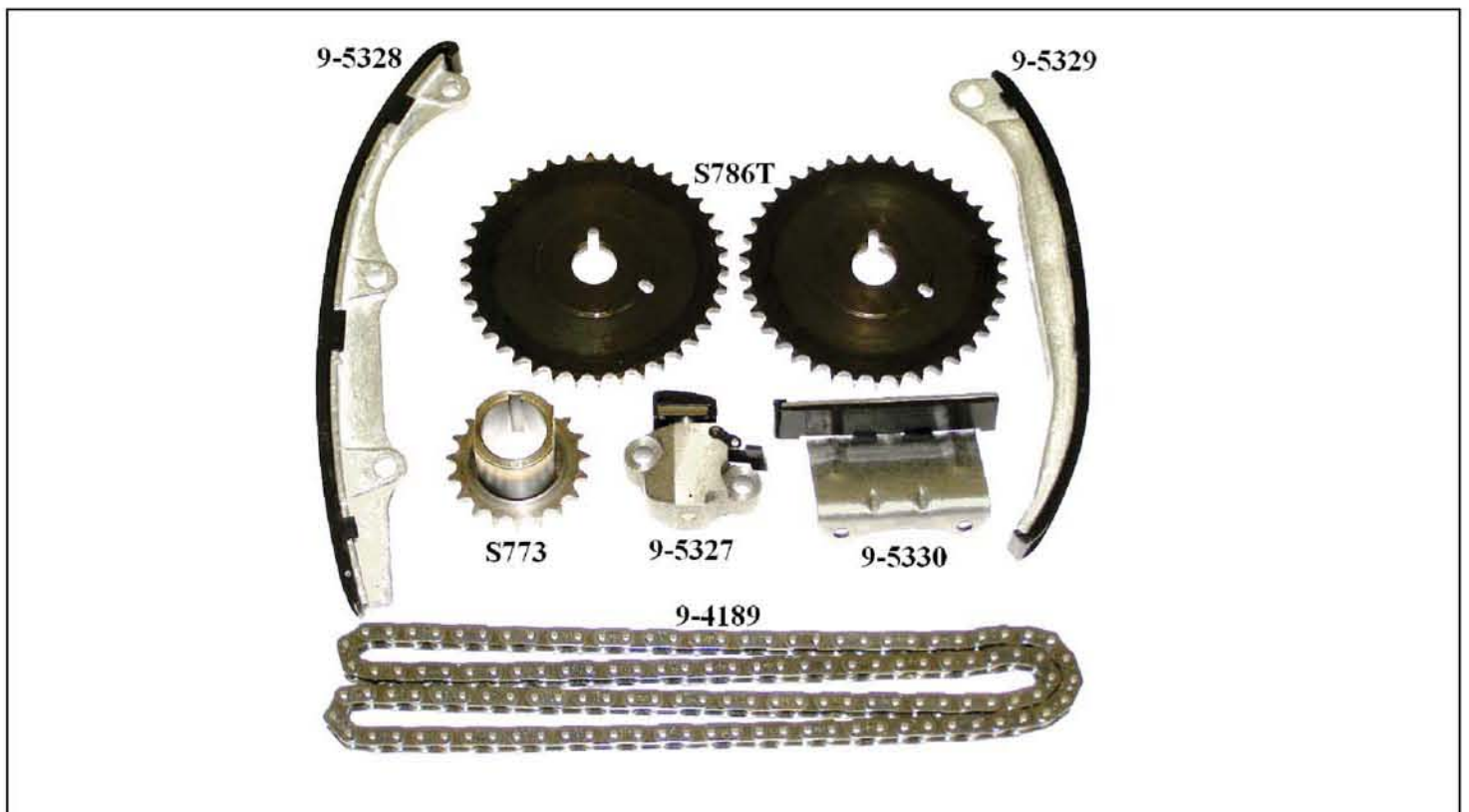
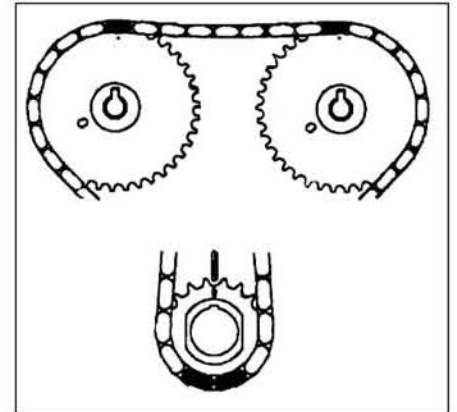



Suzuki

Grand Vitara

**Número de parte
P-1004S**

DESCRIPCIÓN	PART #	OE #



Toyota

**Camry, Celica, Rav4, Solara L4
2.0L, L4 2.2L (1996-2000)**

**Número de parte
BK-199**

DESCRIPCIÓN		PART #	OE #
CORREA	163T	B199	1356809041
Tensor Auxiliar, Rueda Loca (Superior)		9-5301	1350574011
Tensor Auxiliar, Rueda Loca (Inferior)		9-5302	1350363011





Toyota

Celica, Corona, Hi-Lux
20R 1975-80
22R 1981-82

Número de parte
9-4076S

20R (2189cc) . 22R (2366cc) 4 Cil.

Descripción	Número de parte	OE#
† Árbol de levas	36T S483	1352338011
† Cigüeñal	18T S459	1352138010
† Cadena	98L 9-4076	1350638010
† Tensor	9-5016	1354038012
† Guía , (Interno)	9-5025	1356138010
† Guía , (Externo)	9-5026	1356238010
† Timing Kit	9-4076S	



Toyota	Pickup, LN40, RN3, 4 Runner, Celica, RA6 1983-84	Número de parte 9-4141S
	22R 2.4L (2366CC) 4 Cyl.	

Descripción	Número de parte	OE#
† Árbol de levas	36T S600	1352335020
† Cigüeñal	18T S593	1352175010
† Cadena	98L 9-4141	1350635010
† Tensor	9-5100	1354035011
† Damper, (DER.)	9-5101	1356235010
† Damper, (IZQ.)	9-5102	1356135010
† Timing Kit	9-4141S	

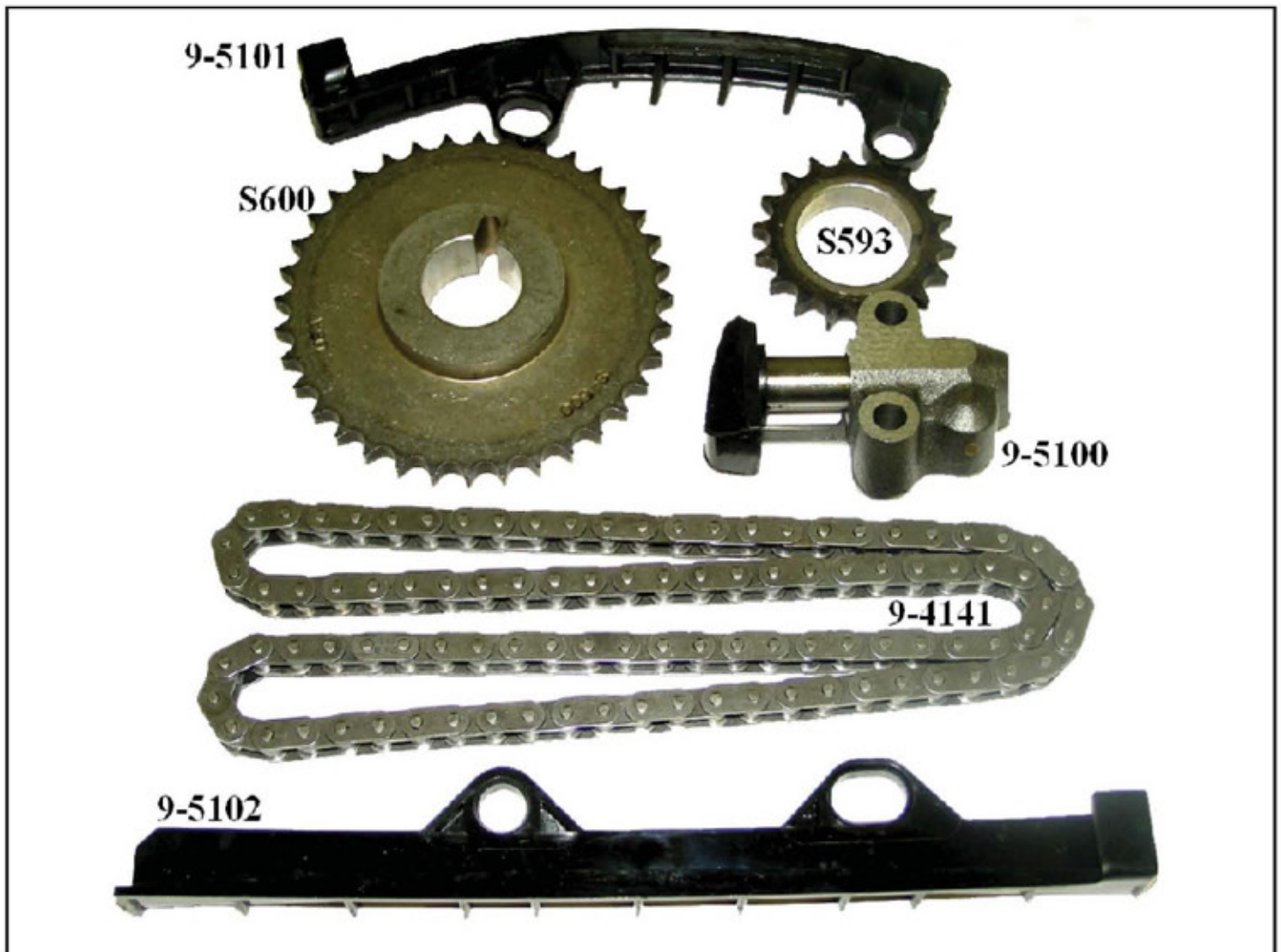



Toyota

4Runner, Celica, Pick Up, Van Wagon.
1985-95

Número de parte
9-4148S

22R -EC, TEC (2366cc) 4 Cil.

Descripción	Número de parte	OE#	
† Árbol de levas	36T	S600	1352335020
† Cigüeñal	18T	S593	1352175010
† Cadena	96L	9-4148	1350635030
† Tensor		9-5100	1354035011
† Guía , (DER.)		9-5132	1356235020
† Guía , (IZQ.)		9-5133	1356135020
† Timing Kit		9-4148S	

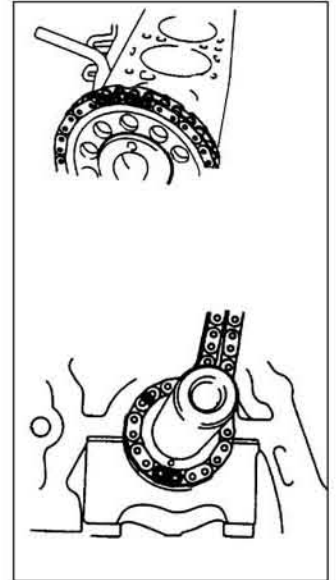

Volkswagen

**Audi A4 2001-06 ,
Quattro 2001-05, TT 2000-06
VW Beetle 1999-04, Golf 2000-06,
Jetta 2000-05, Passat 2000-05**
(Engine Codes AWV, AWP, AWW, AWD, APH)

Número de parte
BK306

1.8L (1781cc) Turbo 20V DOHC 4 Cil.

Descripción	Número de parte	OE#
Banda de distribución 150T	B306	06B109119A
Tensor de banda	9-5528	06B109243F
Polea del amortiguador	9-5529	06B109244
Kit de banda	BK306	



Volkswagen

**Beetle, Cabrio, Golf, GTI, Jetta, Passat
1992-02**
(Engine Code ABA)

Número de parte
BK262

2.0L (1984cc) SOHC 4 Cil.

Descripción	Número de parte	OE#
Árbol de levas 44T	S658 2	049109111B
Cigüeñal 22T	S661 2	049105263C
† Banda 124T	B262 1	037109119C
† Tensor de Banda	9-5148	026109243E
† Kit de Banda	BK262	

- 1.- Motor con interferencia
- 2.- para más aplicaciones de los sprockets consulte
Nuestro catalogo completo.





Volkswagen

VW Beetle, Jetta 1998-05.
SEAT Ibiza, Cordoba 2003-07
(Engine Codes AEG, AVH, AZG)

Número de parte
BK296

2.0L (1984CC) SOHC 4 Cyl.

Descripción	Número de parte	OE#
Banda de distribución	138T B296	06A109119C
Tensor de banda	9-5505	06A109479C
Kit de banda	BK296	



Volkswagen

VW Derby 2000-05, Lupo 2004-08,
Polo 2003-07, Van 2003-05
SEAT Ibiza, Cordoba 2003-07

Número de parte
BK408

1.6L

Descripción	Número de parte	OE#
Banda de distribución	B408	038109243M
Tensor de banda	9-9424	030 109 243 P
Kit de banda	BK408	



Volkswagen	Eurovan 2000-04	Número de parte BK402
2.4, 2.5L		

Descripción		Número de parte	OE#
Banda de distribución	122T	B402	074 109 119 R
Tensor de banda		9-9408	074-109-243-C
Kit de banda		BK402	



Volkswagen	Eurovan 2005-08, Bora 2007, Jetta 2005-07	Número de parte BK333
1.9L DIESEL		

Descripción		Número de parte	OE#
Banda de distribución	120T	B333	038109119P
Tensor de banda		9-9420	038109243M
Tensor Auxiliar ò Rueda Loca		9-9421	038109244J
Kit de banda		BK333	



Herko Timing Components es una división de:

HERKOTM
Automotive Group

Wholesale O.E.M. /Aftermarket Parts & Distribution SpecialistsTM

12975 SW 132 Street, Miami FL 33186
PH: 305-971-4997 • FX: 305-971-4998
sales@HERKO.com • www.HERKO.com

© 2011 HERKO INTERNATIONAL, INC